

ELATECH[®] iSync[™]
high performance timing belts



Technology in Motion

ELATECH® iSync™

In the spirit of continuous innovation, in order to answer to the increased need of industry in power transmission, ELATECH® has developed the iSync™ range of belts. iSync™ belts are made with special polyurethane compound and high resistance steel tension cords which are processed with a unique and highly sophisticated technology to get a superior polyurethane belt. iSync™ belts offer optimal performances on all types of industrial applications.

iSync™ belts are able to transmit up to 30% more than conventional T, AT type of belts in the same space or same power with a more compact drive.

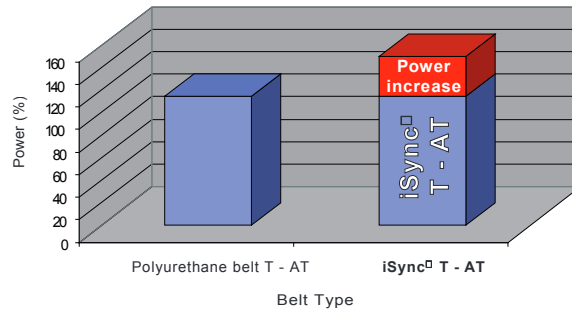

Features

- High power transmission capabilities
- Maintenance free
- Superior length stability
- Clean power transmission with no dust dispersion
- No contamination of object in contact
- Very high chemical resistance and particularly to oils, greases and gasoline
- Superior abrasion resistance
- High quality, thermo-set polyurethane designed specifically for timing belt applications
- Available with either steel or Kevlar® reinforcement
- Application temperature -10°C - +80 °C (standard). Up to +125 °C with special compound PU 53.

Typical application fields

ELATECH® iSync™ belts are suitable for power transmission drives where high precision is needed, cleanliness is critical and in difficult environment (presence of chemicals).

- Plotters
- Office automation
- Medical technology
- Packaging machines
- Swimming pool cleaning robots
- Banking machines
- Coin dispenser
- Vending machines
- Optical instruments
- Cameras
- Machine tools
- Robot arms
- Home appliances
- Vacuum systems
- Food processing machines
- Textile machines
- Gardening equipment and machines

Applications with special backing and cleats are specifically designed for special heavy duty conveying drives.

Available profile range

ELATECH® iSync™ belts are available in a standard range in the following profile range:

T2,5, T5, T10, AT5, AT10, L

As special the following profile can be manufactured on request MXL, H, HTD5M, DD double sided executions.

Tension cords

ELATECH® iSync™ timing belts are manufactured with high tensile strength steel cords as standard. All technical data shown in the catalogue are valid for standard cords. Belt with special cords have different mechanical and chemical properties. Special type of tension member such as stainless steel, HFE high flexibility or aramid fiber (Kevlar®) are available on request for special applications.

Aramid (Kevlar®) tension cords are used where non-magnetic drives are requested.

Stainless steel is used where high corrosion resistance is required.

Fiberglass and polyester are used where high flexibility and water resistance are required.

FDA - Approved Belts

ELATECH® has developed a special formulation for iSync™ moulded belts for application in:

- packing
- conveying
- processing

of dairy, meat and food products which complies to the U.S. Food and Drugs Administration (FDA) law and regulations.

Please contact our Sales Department.

Standard belt sizes - single tothing

T2,5	
Number of teeth z	Length [mm]
48	120
58	145
64	160
71	177,5
72	180
80	200
84	210
92	230
98	245
106	265
111	277,5
114	285
116	290
122	305
127	317,5
132	330
137	342,5
152	380
168	420
192	480
200	500
216	540
240	600
260	650
312	780
366	915
380	950
590	1475

T5			
Number of teeth z	Length [mm]	Number of teeth z	Length [mm]
33	165	110	550
37	185	112	560
40	200	115	575
43	215	118	590
44	220	120	600
45	225	122	610
49	245	124	620
50	250	125	625
51	255	126	630
52	260	128	640
54	270	130	650
55	275	132	660
56	280	135	675
59	295	138	690
60	300	140	700
61	305	144	720
64	320	145	725
65	325	150	750
66	330	156	780
68	340	160	800
70	350	163	815
71	355	166	830
72	360	168	840
73	365	170	850
75	375	172	860
78	390	180	900
80	400	188	940
82	410	198	990
84	420	200	1000
85	425	215	1075
86	430	220	1100
88	440	223	1115
89	445	228	1140
90	450	240	1200
91	455	243	1215
92	460	253	1265
95	475	263	1315
96	480	270	1350
100	500	271	1355
102	510	276	1380
105	525	288	1440
109	545		

T10			
Number of teeth z	Length [mm]	Number of teeth z	Length [mm]
26	260	97	970
32	320	98	980
35	350	100	1000
37	370	101	1010
40	400	105	1050
41	410	108	1080
44	440	110	1100
45	450	111	1110
48	480	114	1140
50	500	115	1150
53	530	120	1200
55	550	121	1210
56	560	124	1240
60	600	125	1250
61	610	130	1300
63	630	132	1320
65	650	135	1350
66	660	139	1390
69	690	140	1400
70	700	142	1420
72	720	144	1440
75	750	145	1450
78	780	146	1460
80	800	150	1500
81	810	156	1560
84	840	160	1600
85	850	161	1610
88	880	170	1700
89	890	175	1750
90	900	178	1780
91	910	180	1800
92	920	188	1880
95	950	196	1960
96	960	225	2250

VACUUM - T10	
Number of teeth z	Length [mm]
63	630
92	920

Order example
ELATECH® iSync™ Timing Belt U 420 T5 / 16

Standard belt sizes Dual toothing

AT5	
Number of teeth z	Length [mm]
45	225
51	255
56	280
60	300
68	340
75	375
78	390
84	420
90	450
91	455
100	500
109	545
120	600
122	610
132	660
142	710
144	720
150	750
156	780
165	825
172	860
195	975
210	1050
225	1125
300	1500

AT10	
Number of teeth z	Length [mm]
50	500
53	530
56	560
58	580
60	600
61	610
66	660
70	700
73	730
78	780
80	800
84	840
88	880
89	890
92	920
96	960
98	980
100	1000
101	1010
105	1050
108	1080
110	1100
115	1150
120	1200
121	1210
125	1250
128	1280
130	1300
132	1320
135	1350
136	1360
140	1400
142	1420
148	1480
150	1500
160	1600
170	1700
172	1720
180	1800
186	1860
194	1940

DT5	
Number of teeth z	Length [mm]
82	410
92	460
118	590
124	620
150	750
163	815
172	860
188	940
220	1100

DT10	
Number of teeth z	Length [mm]
26	260
53	530
63	630
66	660
72	720
84	840
92	920
98	980
121	1210
124	1240
125	1250
132	1320
135	1350
142	1420
161	1610
188	1880

Order example
ELATECH® iSync™ Timing Belt U 620 DT5 / 16

Special belts

Special belts with cleats, backing and with special moulded shape are designed and manufactured to maximize application performance.



L	
Number of teeth z	Length [inch]
60	22,5
64	24
68	25,5
72	27
76	28,5
80	30
136	51
144	54

Order example
ELATECH® iSync™ Timing Belt U 450 AT5 / 16
ELATECH® iSync™ Timing Belt U 225 L / 100

ELATECH® iSync™ high performance endless timing belt technical data

iSync[®] T 2,5

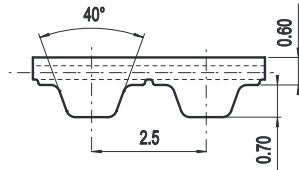

Belt characteristics

- Truly endless polyurethane timing belt with steel tension cords according to DIN 7721 T1
- Metric pitch 2,5 mm
- Ideal for drives where high belt flexibility is required
- Allows the use of small diameter pulleys
- Transmissible power up to 5 kW
- Rpm up to 10.000 [1/min]

- Width tolerance: ±0,3 [mm]
- Thickness tolerance: ±0,2 [mm]

Technical Data

Belt width [mm]	4	6	8	10	12	16	25	32
Allowable tensile load [N]	45	69	103	130	152	220	343	451
Weight [g/m]	6	9	12	15	18	24	37	48

Other widths are available on request.

Tooth shear strength

rpm [min ⁻¹]	M _{spez} [Ncm/cm]	P _{spez} [W/cm]	rpm [min ⁻¹]	M _{spez} [Ncm/cm]	P _{spez} [W/cm]	rpm [min ⁻¹]	M _{spez} [Ncm/cm]	P _{spez} [W/cm]
0	0,47	0,000	1200	0,29	0,361	3400	0,23	0,810
20	0,45	0,010	1300	0,28	0,385	3600	0,22	0,845
40	0,44	0,018	1400	0,28	0,408	3800	0,22	0,880
60	0,43	0,027	1440	0,28	0,417	4000	0,22	0,914
80	0,42	0,035	1500	0,27	0,431	4500	0,21	0,996
100	0,41	0,043	1600	0,27	0,454	5000	0,21	1,074
200	0,38	0,080	1700	0,27	0,476	5500	0,20	1,150
300	0,36	0,114	1800	0,26	0,498	6000	0,19	1,223
400	0,35	0,145	1900	0,26	0,519	6500	0,19	1,293
500	0,34	0,175	2000	0,26	0,541	7000	0,19	1,360
600	0,33	0,204	2200	0,25	0,582	7500	0,18	1,426
700	0,32	0,232	2400	0,25	0,622	8000	0,18	1,489
800	0,31	0,259	2600	0,24	0,662	8500	0,17	1,551
900	0,30	0,286	2800	0,24	0,700	9000	0,17	1,611
1000	0,30	0,311	3000	0,24	0,715	9500	0,17	1,668
1100	0,29	0,336	3200	0,23	0,738	10000	0,16	1,725

The total power "P" and the total torque "M" transmitted by the belt, are calculated with the following formulas:

$$P \text{ [kW]} = P_{spez} \cdot z_e \cdot z_k \cdot b / 1000$$

$$M \text{ [Nm]} = M_{spez} \cdot z_e \cdot z_k \cdot b / 100$$

$$z_e = \frac{z_k}{180} \cdot \arccos \left[\frac{t \cdot (z_g - z_k)}{2 \cdot \pi \cdot A} \right]$$

- P = power in kW
- M = torque in Nm
- P_{spez} = specific power
- M_{spez} = specific torque
- z_e = number of teeth in mesh of the small pulley
- z_{emax} = 12
- z_k = number of teeth of the small pulley
- b = belt width in cm
- A = centre distance [mm]
- t = pitch

Flexibility

Minimum pulley number of teeth and minimum idler diameter			
Drive without reverse bending		Timing pulley z _{min}	10
		Flat idler running on belt teeth d _{min}	15 mm
Drive with reverse bending		Timing pulley z _{min}	18
		Flat idler running on belt back d _{min}	15 mm

iSync[□] T 5 / T 5 Dual

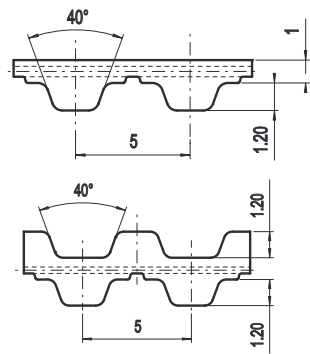

Belt characteristic

- Truly endless polyurethane timing belt with steel tension cords according to DIN 7721 T1
- Metric pitch 5 mm
- Ideal for drives where high belt flexibility is required
- Allows the use of small diameter pulleys
- Rpm up to 10.000 [1/min]

- Width tolerance: ±0,5 [mm]
- Thickness tolerance: ±0,15 [mm]

Technical Data

Belt width [mm]	10	12	16	25	32	50	75	100
Allowable tensile load [N]	430	520	690	1090	1380	2170	3290	4160
Weight [g/m]	24	28	38	60	77	120	180	240
Weight DT5 [g/m]	27	32	43	68	97	138	210	270

Other widths are available on request.

Tooth shear strength

rpm [min ⁻¹]	M _{spez} [Ncm/cm]	P _{spez} [W/cm]	rpm [min ⁻¹]	M _{spez} [Ncm/cm]	P _{spez} [W/cm]	rpm [min ⁻¹]	M _{spez} [Ncm/cm]	P _{spez} [W/cm]
0	2,523	0,000	1200	1,607	2,019	3400	1,248	4,444
20	2,458	0,051	1300	1,580	2,151	3600	1,229	4,632
40	2,403	0,101	1400	1,555	2,279	3800	1,209	4,812
60	2,354	0,148	1440	1,545	2,330	4000	1,191	4,988
80	2,312	0,194	1500	1,532	2,406	4500	1,149	5,414
100	2,276	0,238	1600	1,510	2,529	5000	1,111	5,818
200	2,135	0,447	1700	1,489	2,651	5500	1,078	6,206
300	2,032	0,638	1800	1,470	2,770	6000	1,046	6,571
400	1,951	0,817	1900	1,451	2,888	6500	1,017	6,924
500	1,884	0,987	2000	1,433	3,001	7000	0,991	7,262
600	1,829	1,149	2200	1,400	3,226	7500	0,966	7,588
700	1,781	1,306	2400	1,371	3,445	8000	0,943	7,897
800	1,738	1,456	2600	1,342	3,654	8500	0,920	8,191
900	1,701	1,603	2800	1,317	3,860	9000	0,900	8,480
1000	1,667	1,745	3000	1,306	3,940	9500	0,880	8,758
1100	1,635	1,884	3200	1,292	4,059	10000	0,862	9,027

The total power "P" and the total torque "M" transmitted by the belt, are calculated with the following formulas:

$$P \text{ [kW]} = P_{\text{spez}} \cdot z_e \cdot z_k \cdot b / 1000$$

$$M \text{ [Nm]} = M_{\text{spez}} \cdot z_e \cdot z_k \cdot b / 100$$

$$z_e = \frac{z_k}{180} \cdot \arccos \cdot \frac{t \cdot (z_g - z_k)}{2 \cdot \pi \cdot A}$$

- P = power in kW
- M = torque in Nm
- P_{spez} = specific power
- M_{spez} = specific torque
- z_e = number of teeth in mesh of the small pulley
- z_{emax} = 12
- z_k = number of teeth of the small pulley
- b = belt width in cm
- A = centre distance [mm]
- t = pitch

Flexibility

Minimum pulley number of teeth and minimum idler diameter			
Drive without reverse bending		Timing pulley z _{min}	10
		Flat idler running on belt teeth d _{min}	30 mm
Drive with reverse bending		Timing pulley z _{min}	15
		Flat idler running on belt back d _{min}	30 mm

iSync[®]
T 10 / T 10 Dual

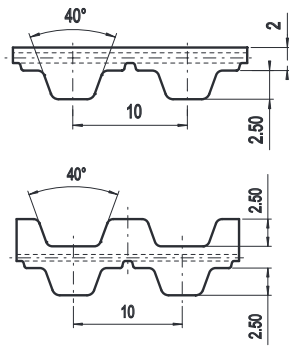
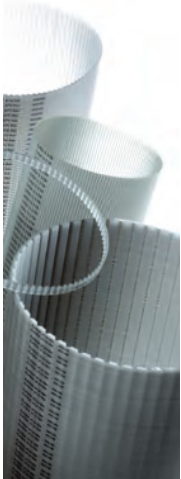

Belt characteristics

- Truly endless polyurethane timing belt with steel tension cords according to DIN 7721 T1
- Metric pitch 10 mm
- Ideal for drives where high belt flexibility is required
- Allows the use of small diameter pulleys
- Rpm up to 10.000 [1/min]

- Width tolerance: ±0,5 [mm]
- Thickness tolerance: ±0,2 [mm]

Technical Data

Belt width [mm]	10	16	25	32	50	75	100	150
Allowable tensile load [N]	890	1520	2280	3040	4680	7080	9490	14170
Weight [g/m]	50	77	120	155	240	365	480	725
Weight DT10 [g/m]	62	92	145	190	290	430	570	900

Other widths are available on request.

Tooth shear strength

rpm [min ⁻¹]	M _{spez} [Ncm/cm]	P _{spez} [W/cm]	rpm [min ⁻¹]	M _{spez} [Ncm/cm]	P _{spez} [W/cm]	rpm [min ⁻¹]	M _{spez} [Ncm/cm]	P _{spez} [W/cm]
0	8,244	0,000	1200	4,808	6,042	3400	3,460	12,318
20	8,009	0,168	1300	4,708	6,409	3600	3,385	12,761
40	7,805	0,327	1400	4,614	6,764	3800	3,312	13,179
60	7,627	0,479	1440	4,577	6,902	4000	3,245	13,592
80	7,472	0,626	1500	4,526	7,109	4500	3,088	14,549
100	7,339	0,768	1600	4,444	7,445	5000	2,946	15,424
200	6,804	1,425	1700	4,366	7,771	5500	2,817	16,224
300	6,411	2,014	1800	4,292	8,090	6000	2,701	16,969
400	6,105	2,557	1900	4,222	8,401	6500	2,593	17,646
500	5,857	3,066	2000	4,157	8,706	7000	2,492	18,269
600	5,648	3,549	2200	4,033	9,291	7500	2,398	18,836
700	5,467	4,007	2400	3,920	9,851	8000	2,311	19,359
800	5,306	4,445	2600	3,815	10,386	8500	2,228	19,832
900	5,163	4,866	2800	3,718	10,901	9000	2,150	20,264
1000	5,034	5,271	3000	3,680	11,097	9500	2,077	20,661
1100	4,916	5,663	3200	3,626	11,389	10000	2,007	21,015

The total power "P" and the total torque "M" transmitted by the belt, are calculated with the following formulas:

$$P \text{ [kW]} = P_{\text{spez}} \cdot z_e \cdot z_k \cdot b / 1000$$

$$M \text{ [Nm]} = M_{\text{spez}} \cdot z_e \cdot z_k \cdot b / 100$$

$$z_e = \frac{z_k \cdot \arccos \left(\frac{t \cdot (z_g - z_k)}{2 \cdot \pi \cdot A} \right)}{180}$$

- P = power in kW
- M = torque in Nm
- P_{spez} = specific power
- M_{spez} = specific torque
- z_e = number of teeth in mesh of the small pulley
- z_{emax} = 12
- z_k = number of teeth of the small pulley
- b = belt width in cm
- A = centre distance [mm]
- t = pitch

Flexibility

Minimum pulley number of teeth and minimum idler diameter			
Drive without reverse bending		Timing pulley z _{min}	12
		Flat idler running on belt teeth d _{min}	60 mm
Drive with reverse bending		Timing pulley z _{min}	20
		Flat idler running on belt back d _{min}	60 mm

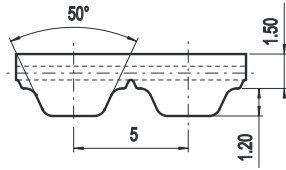
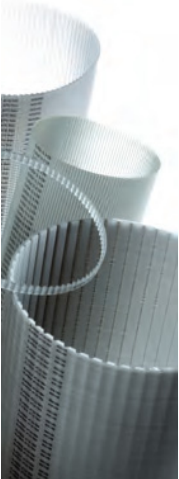

Belt characteristics

- Truly endless polyurethane timing belt with steel tension cords.
- Metric pitch 5 mm
- Tooth profile and dimension are optimised to guarantee uniform load distribution and minimum deformation under load
- High resistance and low stretch steel cords to guarantee high stability and low elongation
- Reduced polygonal effect with reduced drive vibration and noise
- Rpm up to 10.000 [1/min]

- Width tolerance: ±0,5 [mm]
- Thickness tolerance: ±0,15 [mm]

Technical Data

Belt width [mm]	6	10	16	25	32	50	75	100
Allowable tensile load [N]	430	790	1350	2200	2950	4700	7100	9500
Weight [g/m]	21	34	54	86	110	175	260	350

Other widths are available on request.

Tooth shear strength

rpm [min ⁻¹]	M _{spez} [Ncm/cm]	P _{spez} [W/cm]	rpm [min ⁻¹]	M _{spez} [Ncm/cm]	P _{spez} [W/cm]	rpm [min ⁻¹]	M _{spez} [Ncm/cm]	P _{spez} [W/cm]
0	3,813	0,000	1200	2,668	3,352	3400	1,993	7,096
20	3,758	0,079	1300	2,620	3,566	3600	1,954	7,368
40	3,708	0,155	1400	2,574	3,773	3800	1,917	7,627
60	3,663	0,230	1440	2,557	3,855	4000	1,881	7,879
80	3,623	0,304	1500	2,531	3,975	4500	1,799	8,479
100	3,586	0,376	1600	2,491	4,173	5000	1,725	9,032
200	3,448	0,722	1700	2,452	4,365	5500	1,658	9,549
300	3,343	1,050	1800	2,416	4,554	6000	1,596	10,029
400	3,235	1,355	1900	2,381	4,737	6500	1,539	10,473
500	3,137	1,642	2000	2,348	4,918	7000	1,485	10,887
600	3,050	1,916	2200	2,285	5,265	7500	1,436	11,278
700	2,972	2,178	2400	2,229	5,601	8000	1,389	11,635
800	2,900	2,430	2600	2,175	5,923	8500	1,346	11,980
900	2,834	2,671	2800	2,125	6,231	9000	1,304	12,289
1000	2,775	2,905	3000	2,106	6,352	9500	1,264	12,576
1100	2,719	3,132	3200	2,079	6,531	10000	1,228	12,854

The total power "P" and the total torque "M" transmitted by the belt, are calculated with the following formulas:

$$P \text{ [kW]} = P_{spez} \cdot z_e \cdot z_k \cdot b / 1000$$

$$M \text{ [Nm]} = M_{spez} \cdot z_e \cdot z_k \cdot b / 100$$

$$z_e = \frac{z_k}{180} \cdot \arccos \left(\frac{t \cdot (z_g - z_k)}{2 \cdot \pi \cdot A} \right)$$

- P = power in kW
- M = torque in Nm
- P_{spez} = specific power
- M_{spez} = specific torque
- z_e = number of teeth in mesh of the small pulley
- z_{emax} = 12
- z_k = number of teeth of the small pulley
- b = belt width in cm
- A = centre distance [mm]
- t = pitch

Flexibility

Minimum pulley number of teeth and minimum idler diameter			
Drive without reverse bending		Timing pulley z _{min}	15
		Flat idler running on belt teeth d _{min}	25 mm
Drive with reverse bending		Timing pulley z _{min}	20
		Flat idler running on belt back d _{min}	60 mm

iSync[®] AT 10

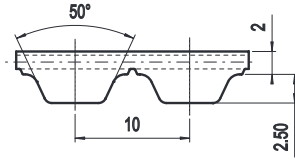
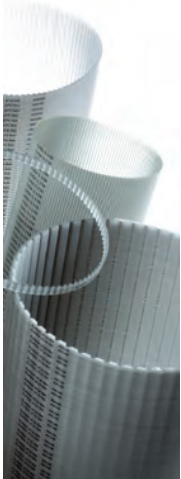

Belt characteristics

- Truly endless polyurethane timing belt with steel tension cords.
- Metric pitch 10 mm
- Tooth profile and dimension are optimised to guarantee uniform load distribution and minimum deformation under load
- High resistance and low stretch steel cords to guarantee high stability and low elongation
- Reduced polygonal effect with reduced drive vibration and noise
- Rpm up to 10.000 [1/min]

- Width tolerance: ±0,5 [mm]
- Thickness tolerance: ±0,2 [mm]

Technical Data

Belt width [mm]	16	25	32	50	75	100	150
Allowable tensile load [N]	3150	5450	7100	1100	17200	23000	34600
Weight [g/m]	101	158	200	316	475	630	950

Other widths are available on request.

Tooth shear strength

rpm [min ⁻¹]	M _{spez} [Ncm/cm]	P _{spez} [W/cm]	rpm [min ⁻¹]	M _{spez} [Ncm/cm]	P _{spez} [W/cm]	rpm [min ⁻¹]	M _{spez} [Ncm/cm]	P _{spez} [W/cm]
0	15,903	0,000	1200	10,174	12,785	3400	7,019	24,989
20	15,670	0,328	1300	9,945	13,538	3600	6,838	25,778
40	15,452	0,647	1400	9,731	14,266	3800	6,664	26,516
60	15,246	0,958	1440	9,649	14,550	4000	6,500	27,225
80	15,053	1,261	1500	9,529	14,968	4500	6,120	28,837
100	14,870	1,557	1600	9,340	15,649	5000	5,777	30,248
200	14,103	2,954	1700	9,160	16,305	5500	5,464	31,470
300	13,483	4,236	1800	8,990	16,944	6000	5,179	32,536
400	12,927	5,414	1900	8,828	17,563	6500	4,916	33,460
500	12,439	6,513	2000	8,672	18,162	7000	4,670	34,232
600	12,008	7,545	2200	8,380	19,305	7500	4,441	34,878
700	11,626	8,522	2400	8,113	20,390	8000	4,227	35,409
800	11,282	9,451	2600	7,866	21,414	8500	4,023	35,808
900	10,969	10,337	2800	7,632	22,378	9000	3,832	36,113
1000	10,683	11,186	3000	7,544	22,751	9500	3,651	36,322
1100	10,418	12,000	3200	7,416	23,296	10000	3,479	36,429

The total power "P" and the total torque "M" transmitted by the belt, are calculated with the following formulas:

$$P \text{ [kW]} = P_{\text{spez}} \cdot z_e \cdot z_k \cdot b / 1000$$

$$M \text{ [Nm]} = M_{\text{spez}} \cdot z_e \cdot z_k \cdot b / 100$$

$$z_e = \frac{z_k}{180} \cdot \arccos \cdot \frac{t \cdot (z_g - z_k)}{2 \cdot \pi \cdot A}$$

- P = power in kW
- M = torque in Nm
- P_{spez} = specific power
- M_{spez} = specific torque
- z_e = number of teeth in mesh of the small pulley
- z_{emax} = 12
- z_k = number of teeth of the small pulley
- b = belt width in cm
- A = centre distance [mm]
- t = pitch

Flexibility

Minimum pulley number of teeth and minimum idler diameter			
Drive without reverse bending		Timing pulley z _{min}	15
		Flat idler running on belt teeth d _{min}	50 mm
Drive with reverse bending		Timing pulley z _{min}	25
		Flat idler running on belt back d _{min}	120 mm

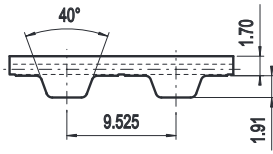
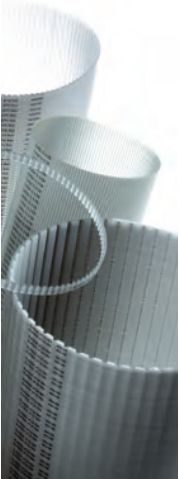

Belt characteristics

- Truly endless polyurethane timing belt with steel tension cords and trapezoidal tooth profile according to DIN/ISO 5296.
- Imperial pitch 3/8" = 9,525 mm
- Mainly used in applications where inch pitch is an advantage
- Transmissible power up to 20 kW
- Rpm up to 10.000 [1/min]

- Width tolerance: ±0,5 [mm]
- Thickness tolerance: ±0,2 [mm]

Technical Data

Belt width [inch]	0,50	0,75	1,00	1,50	2,00	3,00	4,00
Allowable tensile load [N]	1140	1770	2400	3540	4810	7210	9610
Weight [g/m]	50	80	100	150	200	300	400

Other widths are available on request.

Tooth shear strength

rpm [min ⁻¹]	M _{spez} [Ncm/cm]	P _{spez} [W/cm]	rpm [min ⁻¹]	M _{spez} [Ncm/cm]	P _{spez} [W/cm]	rpm [min ⁻¹]	M _{spez} [Ncm/cm]	P _{spez} [W/cm]
0	5,852	0,000	1200	3,393	4,263	3400	2,441	8,689
20	5,673	0,119	1300	3,321	4,521	3600	2,388	9,000
40	5,518	0,231	1400	3,256	4,774	3800	2,336	9,295
60	5,383	0,338	1440	3,230	4,871	4000	2,288	9,581
80	5,266	0,441	1500	3,194	5,017	4500	2,177	10,258
100	5,165	0,541	1600	3,137	5,255	5000	2,077	10,874
200	4,789	1,003	1700	3,082	5,486	5500	1,986	11,437
300	4,516	1,419	1800	3,029	5,709	6000	1,903	11,953
400	4,304	1,803	1900	2,980	5,930	6500	1,827	12,433
500	4,131	2,163	2000	2,933	6,143	7000	1,755	12,867
600	3,984	2,503	2200	2,845	6,555	7500	1,689	13,263
700	3,857	2,827	2400	2,765	6,949	8000	1,627	13,626
800	3,744	3,137	2600	2,692	7,330	8500	1,569	13,965
900	3,644	3,434	2800	2,623	7,689	9000	1,513	14,258
1000	3,553	3,721	3000	2,559	8,039	9500	1,461	14,537
1100	3,470	3,997	3200	2,498	8,371	10000	1,411	14,779

The total power "P" and the total torque "M" transmitted by the belt, are calculated with the following formulas:

$$P \text{ [kW]} = P_{spez} \cdot z_e \cdot z_k \cdot b / 1000$$

$$M \text{ [Nm]} = M_{spez} \cdot z_e \cdot z_k \cdot b / 100$$

$$z_e = \frac{z_k}{180} \cdot \arccos \cdot \frac{t \cdot (z_g - z_k)}{2 \cdot \pi \cdot A}$$

- P = power in kW
- M = torque in Nm
- P_{spez} = specific power
- M_{spez} = specific torque
- z_e = number of teeth in mesh of the small pulley
- z_{emax} = 12
- z_k = number of teeth of the small pulley
- b = belt width in cm
- A = centre distance [mm]
- t = pitch

Flexibility

Minimum pulley number of teeth and minimum idler diameter			
Drive without reverse bending		Timing pulley z _{min}	15
		Flat idler running on belt teeth d _{min}	60 mm
Drive with reverse bending		Timing pulley z _{min}	20
		Flat idler running on belt back d _{min}	60 mm