

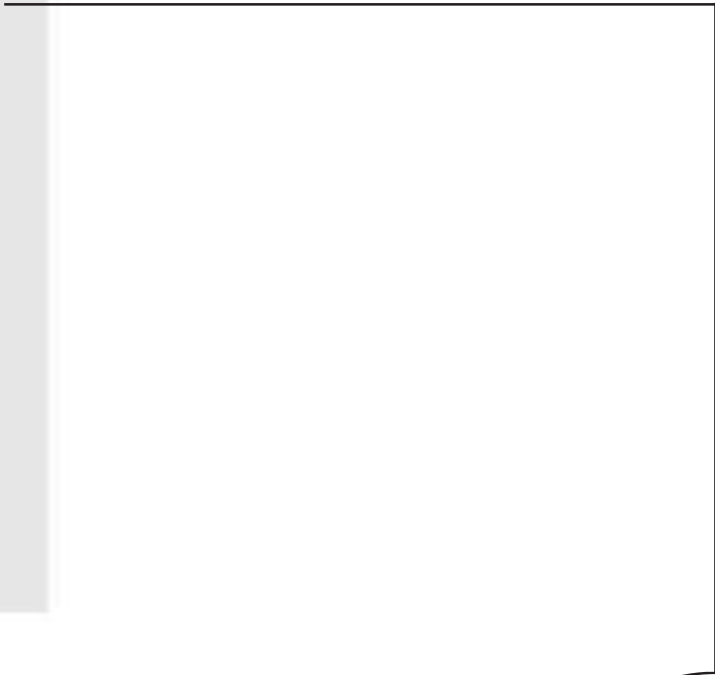

S
U
B
S
U
E

ENGINEERING DATA



CHAIN SELECTION - GENERAL CONSIDERATION

In order to ensure a correct approach to the selection of conveyor chains, the following points should be considered:

- 1) TYPE OF CONVEYOR
- 2) TOTAL LOAD TO BE CARRIED
- 3) CHAIN SPEED
- 4) CHAIN PITCH
- 5) TYPE OF ATTACHMENT
- 6) OPERATING CONDITIONS
- 7) LUBRICATION
- 8) CHAIN BREAKING LOAD

1) TYPE OF CONVEYOR

Conveyor chains are classified in two categories:

- a) sliding
- b) rolling

These two categories are further subdivided into conveyors that are:

- a) horizontal,
- b) inclined,
- c) vertical,
- d) combination.

2) TOTAL LOAD TO BE CARRIED

This is the weight of the carried material on the conveyor chain plus the weight of any attachments and / or carriers (i.e. slats, swing trays, crossbars, fasteners, etc.).

It is essential that the load distribution is considered since the calculation factors for concentrated loads on a limited support surface are different from those for a uniformly distributed load.

3) CHAIN SPEED (V)

The chain speed, the distance travelled by the chain in a given unit of time, is a fundamental factor in determining the conveyor capacity. It is from this parameter that chain pitch and the diameter of the drive and driven wheels is derived.

Fig. 1 illustrates this relationship.

$$V = \frac{P \cdot Z \cdot n}{1000} \text{ [m/min]}$$

P = chain pitch [mm]

Z = number of teeth

n = revolution per minute of the wheel [rpm]

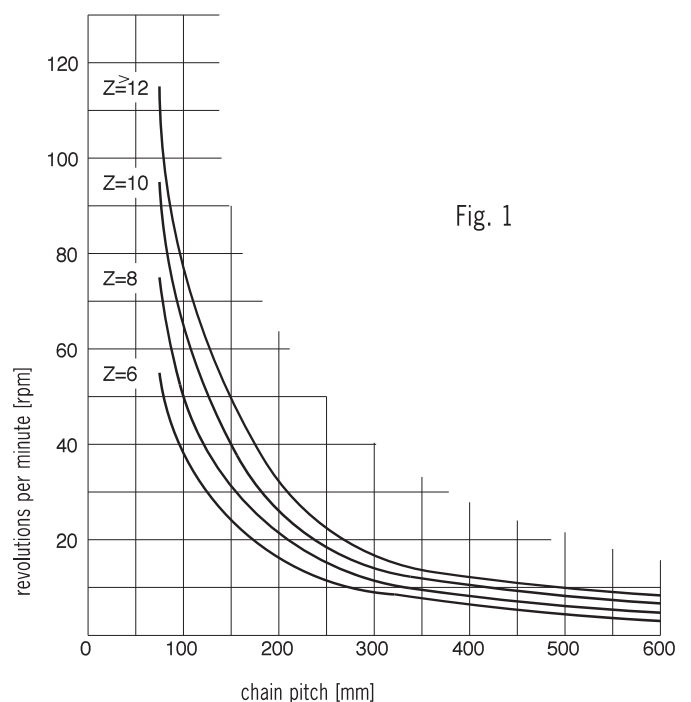

Fig. 1



The maximum recommended speed for conveyor chains is 60 metres per minute with an ideal speed range between 0 and 30 m/min.

Chain speed contributes greatly towards the condition known as **Hunting or Surging**.

Hunting (or Surging) is defined by irregular chain speed, a series of fast and slow chain surges. This condition can seriously compromise the functionality of a chain conveyor, the main factors that can contribute to this effect are outlined as follows:

- The polygonal effect, due to the gearing of the chain with sprockets, (shown in in Fig. 2) can cause a small amount of chain surge. This can be more marked on long pitch chain with number of teeth below 8.
- Cumulative effect of friction along the length of the conveyor (on the drive and return strands): intermittent contact between the chain side plates and the track guides can cause the chain to surge.
- 'Stick slip' is a condition that can occur on slow running conveyors. It is often caused by over lubrication of the chain. The over lubrication floods the chain track with oil or grease and lowers the rolling friction between the chain roller and the track. Once this rolling friction becomes less than that of the rolling friction between the chain bush and the roller bore, the roller stops turning. The lubricant then builds up at the pressure face between the bush and the roller bore creating a vacuum between the two surfaces. With the chain track flooded with oil there is no available friction to turn the roller until the conveyor is stopped or the chain roller to track friction increases. This condition of skidding rollers and rotating rollers can cause the chain speed to fluctuate up and down. Stick slip conditions are more prevalent on lightly loaded conveyors as heavier loads will break the lubrication film on the chain track.
- Uneven loading of the conveyor, along its length, can also contribute towards the stick slip condition.
- On longer conveyors of 80 - 100 metres other factors must be taken into consideration, such as cumulative pitch tolerance.

Hunting / Surging of conveyors maybe eliminated by reducing the rolling friction of the chain. This can be achieved by the use of low friction bushings in the roller bore or by introducing a bearing element into the roller / bush interface / as an alternative, twin track integral ball bearings can be introduced. The additional advantage of this method is the overall reduction of the coefficient of friction of the conveyor. This reduction can have a major influence on the selection of head shaft diameters and motor / gearbox sizes.

For further technical details please contact our technical department.

The following graph shows the speed variation due to the polygonal effect (%).

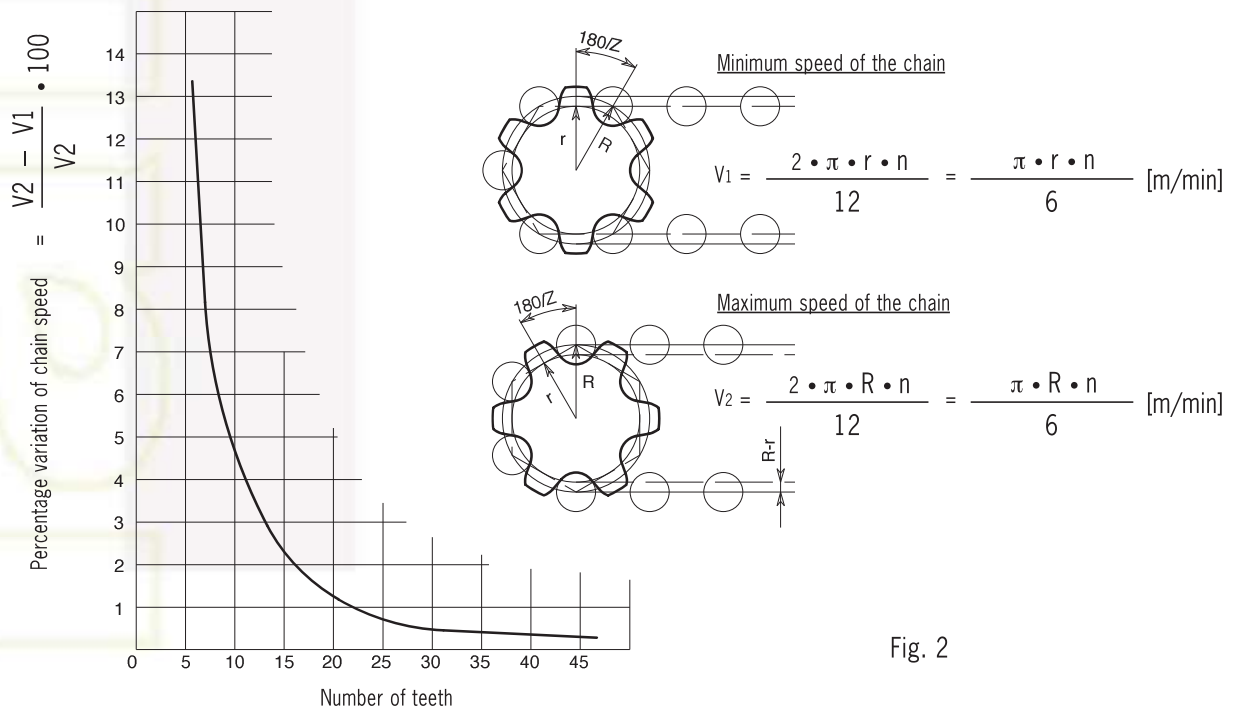

Fig. 2

- n = rpm
- Z = number of teeth of the wheel
- R = pitch radius of the wheel [mm]

$$r = R \cdot \cos \frac{180^\circ}{Z} \text{ [m]}$$

R-r = range of variation of the polygonal effect [mm]



4) CHAIN PITCH

This is the distance expressed in millimetres or inches between two consecutive pin centres of the chain and is determined by the following conveyor characteristics:

- a) chain speed
- b) diameter of drive and driven wheels
- c) conveyor load distribution
- d) spacing of attachments / carriers (i.e. slats, swing trays, crossbars, fasteners, etc).

5) CHAIN ATTACHMENTS

Slats / carriers are attached to the chain by means of angle iron sections welded to the chain plates or they may be extensions of the chain plates. Chain attachments are defined by the dimensions, shape, number per linear metre, and the type of material to be conveyed.

6) OPERATING CONDITIONS

The environment in which the conveyor chain is to operate has an enormous influence on its design. The choice of material, quality of materials, tolerances, production methods, anti corrosion treatments and safety factors are all dependent on the following:

- degree of cleanliness
- operating temperature
- presence of abrasive substances
- humidity / atmospheric substances
- presence of aggressive chemical substances
- etc.

Knowledge of the operating temperature is particularly important since it affects the breaking load of the chain as demonstrated in Table 1:

TABLE 1

TEMPERATURE	ADJUSTED WORK LOAD
-40° C ~ -20° C	(Maximum allowable work load) x 0,25
-20° C ~ -10° C	(Maximum allowable work load) x 0,30
-10° C ~ 160° C	(Maximum allowable work load) x 1,00
160° C ~ 200° C	(Maximum allowable work load) x 0,75
200° C ~ 300° C	(Maximum allowable work load) x 0,50

For further information on other operational conditions, contact our Technical Office.

7) LUBRICATION

Lubrication of the conveyor chain is essential since it reduces wear and prevents corrosion and oxidation.

It also determines the friction factors and hence the chain pull.

See page 1.7.2 for more information on product, quality and usage.

8) BREAKING LOAD

Expressed in Newton's this is the value given to the point at which the chain will fail in tensile pull.

The data given in the catalogue is based on tensile pull tests at ambient temperature.

The breaking loads given are an average value based on a number of tests.

The range variation, from average, should be considered as no more than 5%.



CHAIN SELECTION - CHAIN PULL

Chain pull is that force required to move the chain, the connected mechanical parts and the load to be conveyed.
The chain pull required for a particular application is dependent on the following factors:

- 1) WEIGHT OF MATERIAL CARRIED
- 2) WEIGHT OF CHAINS AND SUPPORT ELEMENTS (SLATS, SWING TRAYS, CROSSBARS, FASTENERS, ETC.)
- 3) COEFFICIENT OF FRICTION
- 4) SERVICE FACTOR
- 5) GEARING FACTOR

The calculation for chain pull is carried out in two phases:

- the preliminary phase, a calculation which determines the type of chain required by the chain weight and the coefficient of friction.
- the second phase, a control calculation, confirms the preliminary chain weight and coefficient of friction by substituting actual values of the identified chain.

1) WEIGHT OF MATERIAL CARRIED = P1 [kg]

See paragraph 2 of the chapter "Chain selection – General considerations".

2) WEIGHT OF CHAINS = P [kg]

For the preliminary calculations this is the approximate weight of the entire chain circuit including any attachments (slats, swing trays, crossbars, fasteners, etc.). For the control calculation it is the actual weight of the entire chain circuit.

3) COEFFICIENT OF FRICTION

The coefficient of friction is the value that defines the force necessary to overcome resistance to movement when two bodies are in contact. When operating in a "sliding" mode along a track, chains must overcome sliding friction "fr". Typical values for sliding friction coefficients are outlined in the following table.

TABLE 2

BODIES IN CONTACT	fr dry surface	fr lubr. surface
Steel chains on hardwood tracks	0,44	0,29
Steel chains on steel tracks	0,30	0,20
Steel chains on rough or rusty tracks	0,35	0,25
Steel chains on tracks of high density very high molecular weight polyethylene	0,18	0,05

When running on rollers chains must overcome both sliding and rolling friction "fv".

The value of the rolling coefficient in the preliminary calculation is assumed to be $f_v = 0.2$, whilst in the control calculation its value is given as:

$$f_v = C \cdot \frac{d}{D} + \frac{b}{D}$$

where

d = bush outside diameter [mm]

D = Roller outside diameter [mm] (D1, D2 or D3 see catalogue)

b = Coefficient dependent on the type of materials used and the grade of machined surfaces.

= 1 - for steel roller on steel track with smooth surface

= 2 - for steel roller on steel track with rough surface

C = the sliding friction coefficient between bush and roller, outlined in the following table.



TABLE 3

BODIES IN CONTACT	Dry surface "C"	Lubricated surface "C"
Steel roller on steel bush	0,25	0,15
Roller with bronze bush on steel bush	N/A	0,13
Nylon roller on steel bush	0,15	0,10

Important

It is important to note that in the initial stage of movement, the starting friction coefficient can be 1.5 to 3 times greater than the dynamic friction coefficient.

As a general guide, in order to minimise initial friction, the external diameter of the roller should be at least 2.5 times greater than the external diameter of the bush.

4) SERVICE FACTOR = FS

Chain pull must be multiplied by an adjustment coefficient (FS) to take account of operational conditions and characteristics of the conveyors. FS values for the most common applications are outlined in the following table.

TABLE 4

OPERATING CONDITIONS	FS
Load position	
- Centred	1
- Not centred	1,2
Load characteristics	
- Uniform: extent of overloading less than 5%	1
- With minor variations: extent of overloading 5 to 20%	1,2
- With major variations: extent of overloading 20 to 40%	1,5
Frequency of loaded starting/stopping	
- Less than 5 per day	1
- From 5 per day to 2 per hour	1,2
- More than 2 per hour	1,5
Working environment	
- Relatively clean	1
- Quite dusty or dirty	1,2
- Humid, very dirty or corrosive	1,3
Number of hours in use daily	
- Up to 10	1
- More than 10	1,2

To obtain the total FS coefficient, (FS) value for each operational condition must be multiplied together.

5) GEARING FACTOR = FA

This is an adjustment coefficient made to the chain pull, which increases due to the additional friction caused by the rotation of the chain on the drive and driven wheels.

FA = 1,05 for wheels mounted on brass bushes

= 1,03 for wheels mounted on bearings

The sum of all products obtained by multiplying FA for the chain pull in each gearing point determines the new total chain pull.

For the following examples the "FA" values will not be considered.



CHAIN PULL CALCULATIONS (T)

a) Horizontal conveyer with sliding chains

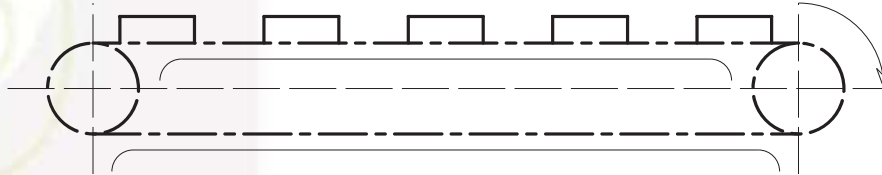

Fig. 3

$$T = 9,81 \frac{(P+P1) \cdot fr \cdot FS}{\text{No. of chains}} \text{ [N]}$$

b) Horizontal conveyer with roller chains

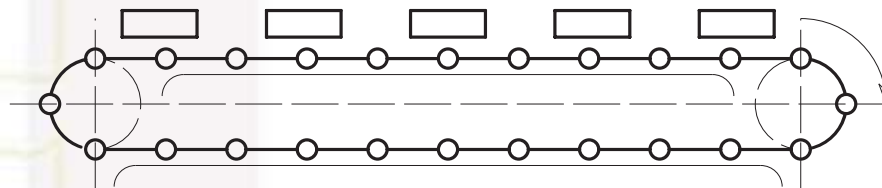

Fig. 4

$$T = 9,81 \frac{(P+P1) \cdot fv \cdot FS}{\text{No. of chains}} \text{ [N]}$$

c) Inclined conveyer with sliding chains

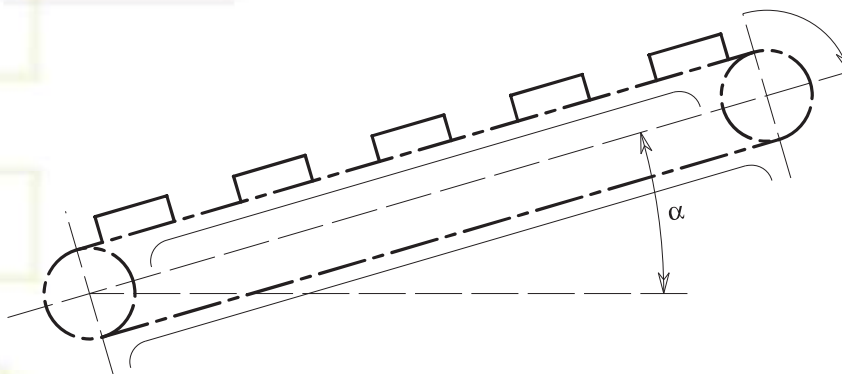

Fig. 5

$$T = 9,81 \frac{[\cos\alpha (P+P1) \cdot fr + \sin\alpha \cdot P1] \cdot FS}{\text{No. of chains}} \text{ [N]}$$



d) Inclined conveyor with roller chains

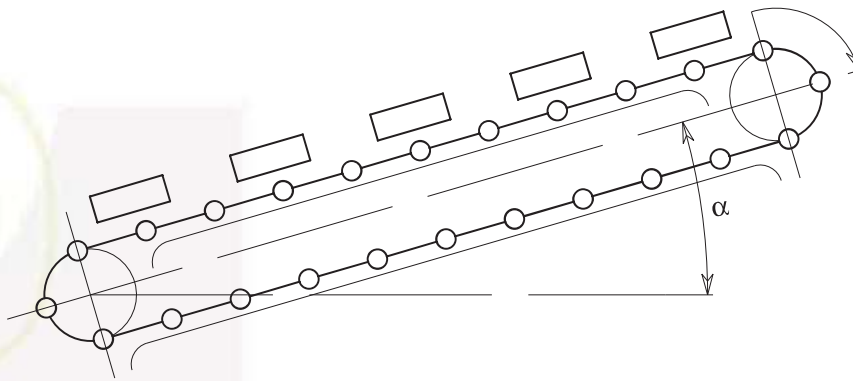

Fig. 6

$$T = 9,81 \frac{[\cos\alpha \cdot (P+P1) \cdot fv + \sin\alpha \cdot P1] \cdot FS}{\text{No. of chains}} \text{ [N]}$$

e) Vertical elevator

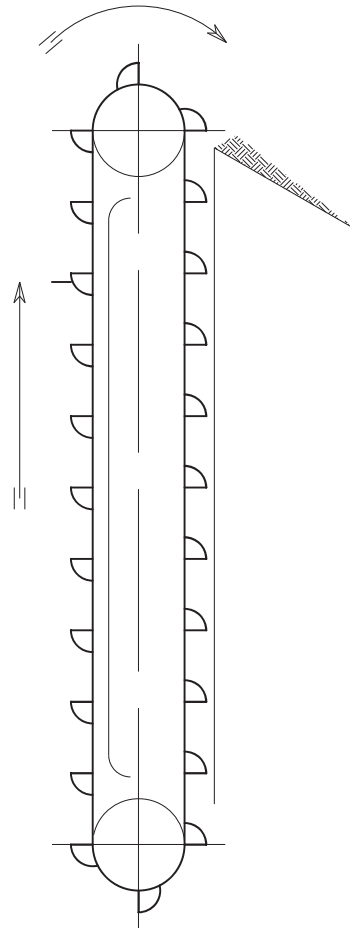

Fig. 7

$$T = 9,81 \frac{(P/2+P) \cdot FS}{\text{No. of chains}} \text{ [N]}$$

N.B.:

For further technical assistance on vertical conveyors not covered in this catalogue, please contact our technical office.



SCRAPER CONVEYORS

To calculate the chain pull of scraper conveyors, additional parameters need to be considered:

f_m	=	coefficient of friction between material to be moved and the side guides (table 5),
L	=	portion of loaded conveyor [m],
Q	=	mass of product to be transported [Tonnes/h],
H	=	height of side guide [m],
B	=	width between guides [m],
β	=	product depth normally not exceed 50-60 % of H ,
γ	=	specific weight of material conveyed. [Tonnes/m ³] (table 5),
v	=	chain speed. [m/sec].

TABLE 5

MATERIAL CONVEYED	Spec. weight γ . [Tonnes/m ³]	Friction coefficient f_m
Oats	0,45	0,7
Wheat	0,75	0,4
Corn	0,8	0,4
Dried barley	0,45	0,7
Rye	0,65	0,4
Rice	0,75	0,4
Linseed	0,7	0,4
Dried malt	0,4	0,4
Wheat flour	0,7	0,4
Corn flour	0,65	0,4
Refined powdered sugar	0,8	0,5
Cement	1,00	0,9
Anthracite coal in pieces	0,7 to 0,9	0,4
Coking coal	0,5	0,7
Dried clay	1,6	0,7
Ashes	0,6	0,6
KLINKER cement gravel	1,3	0,8

** indicative values

a) Horizontal conveyor with sliding chains and material

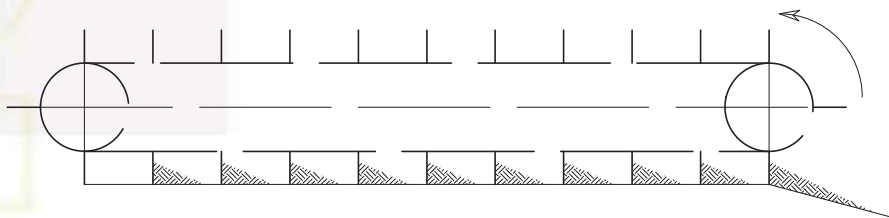

Fig. 8

$$T = 9,81 \frac{[(P \cdot fr + P1 \cdot fm) \cdot FS]}{\text{No. of chains}} \text{ [N]}$$

Where $P1$ can be calculated as follows:

a) $P1 = H \cdot B \cdot L \cdot \beta \cdot \gamma \cdot 1000 \text{ [kg]}$

b) $P1 = \frac{L \cdot Q}{3,6 \cdot v} \text{ [kg]}$

If Q is unknown it can be calculated as follows: $Q = H \cdot B \cdot \beta \cdot \gamma \cdot v \cdot 3600 \text{ [Tonnes/h]}$



b) Horizontal conveyor with roller chains and scraper bars

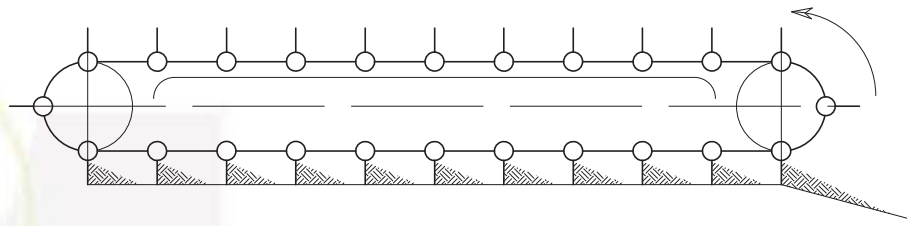

Fig. 9

$$T = 9,81 \frac{[(P \cdot fr + P1 \cdot fm) \cdot FS]}{\text{No. of chains}} \text{ [N]}$$

Where P1 can be calculated as follows:

a) $P1 = H \cdot B \cdot L \cdot \beta \cdot \gamma \cdot 1000 \text{ [kg]}$

b) $P1 = \frac{L \cdot Q}{3,6 \cdot v} \text{ [kg]}$

If Q is unknown it can be calculated as follows: $Q = H \cdot B \cdot \beta \cdot \gamma \cdot v \cdot 3600 \text{ [Tonnes/h]}$

DETERMINING THE TYPE OF CHAIN TO USE

Having established the maximum chain pull, the maximum stress that chain components will be subjected to must then be considered. It is generally accepted that a chain, working at 65% of the breaking load will be stressed beyond the 'elastic limit' of the side plate material. In order to provide a sufficient margin of safety, the chain breaking load should therefore be at least 8 times the maximum working load. This safety margin is known as the safety factor.

It is essential that an adequate safety factor is provided and in cases where variations in chain pull values are difficult to quantify, the Technical Office should be consulted.

In situations where high density loads are moved on small conveyor surface, the calculation of chain pull alone is not always sufficient to identify chain type.

In these instances, the specific pressure values between the rollers/bushes and bushes/pins should also be considered.

If the specific pressure values exceed those listed in table 6-7, then a chain with greater contact surface between the rollers and bushes, or bushes and pins must be considered.

Calculation of bearing pressure

a) roller loading = $\frac{P}{L \cdot Dr} \left[\frac{\text{kgf}}{\text{mm}^2} \right]$

b) pin pressure = $\frac{T}{Lb \cdot Dp} \left[\frac{\text{kgf}}{\text{mm}^2} \right]$

where:

- P = load [kgf] supported by each roller
- T = chain pull [kgf]
- L = distance through roller bore [mm]
- Lb = total bush length [mm]
- Dr = diameter of roller bore [mm]
- Dp = external diameter of pin [mm]



MAXIMUM ALLOWABLE PRESSURES

TABLE 6

MATERIALS IN CONTACT		Max. spec. Press. Kgf/mm ²
BUSH	PIN	
Case-hardened steel	Case-hardened steel	2,5
Case-hardened steel	Hardened-tempered steel	2,1
Cast iron	Case-hardened steel	1,75
Stainless steel	Stainless steel	1,2
Bronze	Case-hardened steel	1

TABLE 7

MATERIALS IN CONTACT		Max. spec. Press. Kgf/mm ²
ROLLER	BUSH	
Case-hardened steel	Case-hardened steel	1
Hardened-tempered steel	Case-hardened steel	1
Cast iron	Case-hardened steel	0,70
Bronze	Case-hardened steel	0,60
Polyethylene A.D.	Case-hardened steel	0,1
Stainless steel	Stainless steel	0,40
Cast iron	Bronze	0,28

CALCULATION OF POWER REQUIRED AT HEAD SHAFT

Once the conveyor's total chain pull has been determined, the following procedure for the calculation of shaft power requirements should be used:

$$M_t = T \cdot \frac{dp}{2} \text{ [kgm]} \quad M_t = 716,2 \cdot \frac{N}{n} \text{ [kgm]}$$

where:

M_t	=	torque [kg m]
N	=	power [CV, Hp or KW]
n	=	head shaft rpm
T	=	total chain pull [kg]
dp	=	PCD of the drive sprockets [m]

From these two relationships it is concluded that:

$$T \cdot \frac{dp}{2} = 716,2 \cdot \frac{N}{n}$$

From which is derived

$$N = \frac{T \cdot dp \cdot n}{2 \cdot 716,2} \text{ [CV]}$$

or

$$N = \frac{T \cdot dp \cdot n}{2 \cdot 973,8} \text{ [KW]}$$

The usable power output of the motor must be determined taking into account losses from reduction devices, belts, etc.



LUBRICATION OF CHAINS

Chain lubrication is essential for the following reasons:

- 1) REDUCTION IN THE COEFFICIENT OF FRICTION
- 2) REDUCING CHAIN WEAR AND SAVING ENERGY
- 3) PREVENTION OF CORROSION
- 4) CORRECT FUNCTIONING OF THE CHAIN

1) REDUCTION IN THE COEFFICIENT OF FRICTION

Friction is defined as the mechanical resistance produced between two surfaces in motion against each other.

There are two basic types of Friction, Static and Dynamic.

Static friction R_s is the resistance given by a surface to relative movement when an external force is applied.

It can also be known as the breakaway friction. Experience shows that to obtain movement of a body of weight P rested on a plane, the force necessary to move that body, F , is a product of the coefficient of static friction, μ and the weight of the body P .

Dynamic friction is the resistance given by a body already in motion, that is the resistance given to an external force exerted to overcome the friction between two surfaces. The force required to keep a body in motion is always less than that to move a body from rest.

Dynamic friction R_d is a product of the coefficient of dynamic friction f and the weight of the body P .

$$R_s = P \cdot \mu \text{ (Kg)}$$

$$R_d = P \cdot f \text{ (Kg)}$$

The value of both μ the coefficient of static friction and f the coefficient of dynamic friction are dependant on the quality of the surfaces in contact, the type of contact (sliding or rolling), the relative speeds between the surfaces and the presence of lubrication.

Fig. 10 shows the influence of relative speed on the coefficient of friction. The curve is divided in three parts:

- part 1 shows friction at very slow speed, in this case the film of lubricant between the two surfaces is not thick enough to prevent contact;
- part 2 is an intermediate condition;
- part 3 shows friction at higher speed when the film of lubricant is thick enough to ensure that motion takes place without direct contact between the two surfaces.

Fig. 10

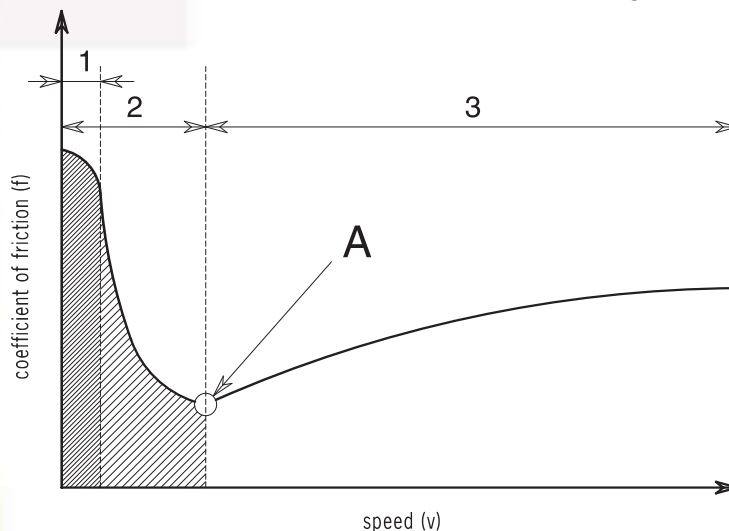

2) REDUCING CHAIN WEAR AND SAVING ENERGY

The absence of a lubricant film causes the rotating parts of the chain to come into direct contact with each other. This in turn causes progressive wear of the mating surfaces, which results in premature failure of the chain. Additional friction caused by premature wear results in an increase in chain pull, requiring a higher power input from the motor, using more energy. The presence of a lubricant prevents metal to metal contact, increases the operating life of the chain and saves a considerable amount of energy.

Figure 11 shows the percentage elongation of a chain, based on working hours and type of lubrication.

Key.

- Percentage elongation of chains working with no pre lubrication or running lubrication.
- Percentage elongation with pre lubrication but no further working lubrication.
- Chain with pre lubrication and then only sporadic re lubrication.

This clearly shows that the lubrication periods are set at too great a time. Wear therefore occurs on a cyclic periods.

- This curve indicates the unsuitability of lubricant used or the under lubrication of the chain.
- Optimum lubrication.

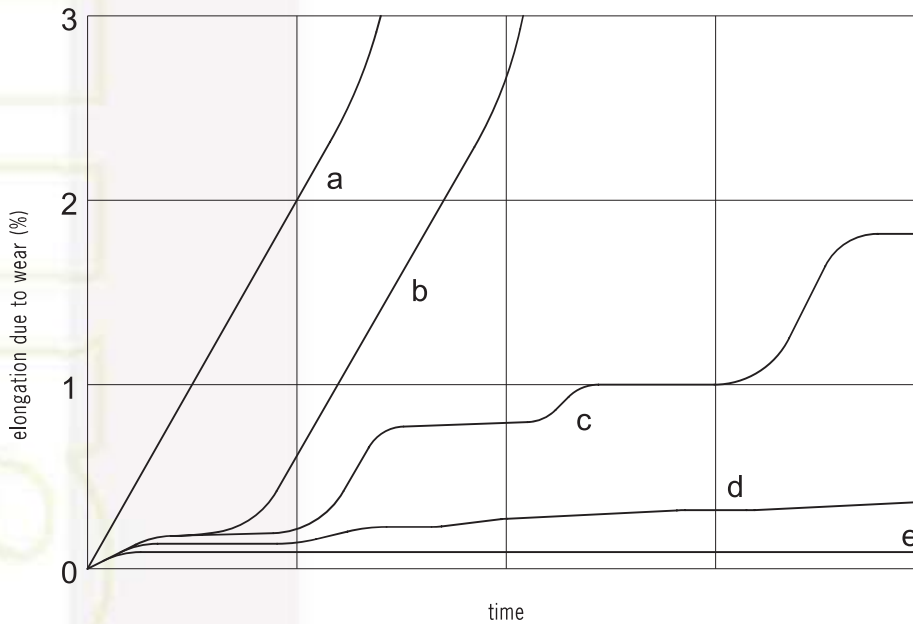

Fig. 11

3) PREVENTION OF CORROSION

Any non-protected metal is subject to oxidation.

This phenomenon is exacerbated by environmental conditions, such as:

- high temperatures
- high humidity
- presence of aggressive chemical substances

Oxidation or corrosion is a serious threat to chain life.

The presence of a lubricant film on the surface of the chain's components, creating a barrier between the chain and the external environment, prevents the formation of oxides and the onset of corrosion.

The effectiveness of this protection can be improved by the addition of corrosion inhibitors within the lubricant.



4) CORRECT FUNCTIONING OF THE CHAIN

Adequate lubrication ensures continuous functioning of the chain and has the additional advantage of reducing operating noise.

CHOICE OF LUBRICANT

It is impossible to prescribe one lubricant for all applications. Many parameters determine the choice of lubricant; but the most important is operating temperature.

For practical purpose, operating temperature can be sub-divided as follows:

- a) Low temperature - - 40°C to 15°C
- b) Normal temperature - 15°C to 110°C
- c) High temperature - 110°C to 250°C
- d) Very high temperature - more than 250°C

A) LOW TEMPERATURE (- 40° C TO 15°C)

When operating temperatures fall below 0 degrees it is necessary to select the correct lubricant to keep the chain in good condition. In very low operating temperatures synthetic oils, with low viscosities are often used. In applications that require no oil contamination or fling off into the surrounding area it is best to apply greases in dispersions that will carry the grease into the round parts of the chain and then dry to allow little or no dripping or fling off. For low temperature conditions we would recommend KLÜBERSYNTH UH14-68N or ISOFLEX grease NBU 15. We do suggest that a lubrication company be contacted to get first hand technical knowledge before a final decision is taken on which lubricant is used.

B) NORMAL TEMPERATURE (+ 15° C TO 110° C WITH POINTS UP TO 150° C)

The use of mineral oils is not recommended; specific lubricants for chains with additives to prevent dripping and improve capillarity are more appropriate. One product which meets these requirements is the grease fluid STRUCTOVIS FHD (KLÜBER LUBRICATION), which has an excellent adhesive capacity to minimise dripping and low surface tension which permits "sapping" of any drops of moisture which may be present on the metallic surface. These attributes ensure maximum lubrication even in the most difficult conditions.

C) HIGH TEMPERATURE (FROM 110° C TO 250° C)

The use of synthetic oils is necessary in this temperature range because their thermal stability is superior to that of mineral oils. Oils containing combinations of solid pigments with a graphite or molybdenun disulphide base are recommended because they provide emergency lubrication and increase the maximum specific pressure value. Additionally these oils contain additives to prevent the formation of sludge. The synthetic oil SYNTHESCO (KLÜBER LUBRICATION) is recommended since it has less tendency to smoke (NON-toxic).

D) VERY HIGH TEMPERATURES

In these temperature conditions, a fluid lubricant is ineffective. A solid lubricant suspended in a synthetic "vehicle" should be used. The synthetic solution evaporates and leaves the lubrication place. A certain quantity of smoke generation is inevitable in this case. The application must be carried out when the chain is cold. WOLFRAKOTE TOP FLUID S (KLUBER LUBRICATION) is recommended.

CLEANING OF CHAINS

The cleaning of chains and tracks along with the correct lubrication of the chain can give vastly improved chain life. In certain conditions re lubrication of a chain without first cleaning the chain and tracks can be detrimental to the running of the conveyor, and will render re lubrication completely ineffectual.

It is recommended that chains be cleaned in the following circumstances:

- Before periods of extended downtime. It is advisable to clean the chains before applying a suitable protective product.
- When the chains reach a point that they are so contaminated that the dirt build up cannot be removed by normal methods.



(i.e. flushing with lubricant, brushing or washing down.) At this point it is recommended that the chain be removed from the conveyor thoroughly cleaned, dipped in a lubricant bath, and allowed to soak for at least 6 hours, before being put back on the conveyor.

- If a reaction takes place between the grease used by the manufacturer and the product used for re lubrication the chains must be removed from the system, degreased and re lubricated before being put back into service.

NOTE.

When washing chains with water or water/detergent mix products it is essential that the chains are re-lubricated with a product that will displace moisture and penetrate into the round parts.

Suggested procedure for cleaning chains.

- 1) Remove chain from conveyor.
- 2) Remove all surface dirt and oil/grease, with rags or brushes
- 3) Wash the chain with a solvent/lubricant mix. Paying attention to remove all contamination from the round parts.
(i.e. ensure all round parts rotate freely and all links articulate.)
- 4) Immerse the cleaned chain in a suitable lubricant bath for a minimum of 6 hours.

INITIAL LUBRICATION

For the initial lubrication of the chains the special lubricant STRUCTOVIS FHD of KLÜBER LUBRICATION is used. The viscous structure of this chain oil distinguishes itself clearly from traditional chain lubricants by the following characteristics:

- high adhesion (anti drop)
- water-repellent
- very good wear protection
- excellent ageing stability
- very good temperature stability up to 150°C

STRUCTOVIS FHD - Chemical physical properties		
Density at 20°C [g/cm³]	DIN 51757	Approx. 0,890
Kinematic viscosity [mm²/sec]	DIN 51561	
	at 40° C	145
	at 50° C	86
	at 100° C	15
Viscosity index	ISO 2909	100
Flash point (°C)	DIN 51376	>250
Pourpoint (°C)	DIN ISO 3016	-12

Since 1979, KLÜBER Lubrication Italia has been subsidiary of the German company KLÜBER Lubrication München KG, which is represented world-wide through 14 productions plants and more than 50 sales offices.

Thanks to a large choice of special lubricants, KLÜBER Lubrication Italia offers solutions for all requirements of lubrication.

KLÜBER Lubrication Italia has the DIN ISO 9002 and DIN ISO 14001 certificates and the EC eco-audit validations EMAS.

KLÜBER Lubricants are also available throughout Europe.

KLÜBER Lubrication Italia s.a.s.
Via Monferrato, 57
20098 S.Giuliano Milanese (MI)
Tel. 02-98213.1 - Fax 02-98.28.15.95
klita@klueber.com



LUBRICATION SYSTEM

Automatic lubricant distribution is always recommended, because it ensures optimum lubricant dosage. This avoids accidental dry operation and prevents over-lubrication and consequent dripping. The lubricant, whether sprayed or atomized, must reach the flanks of the rollers and between the plates of the pins to ensure an even distribution to all parts of chain. Provided a suitable lubricant is used, it is not necessary for the chain to be soaked, merely dampened. Lubrication frequencies or quantities cannot be given here, every case should be individually assessed.

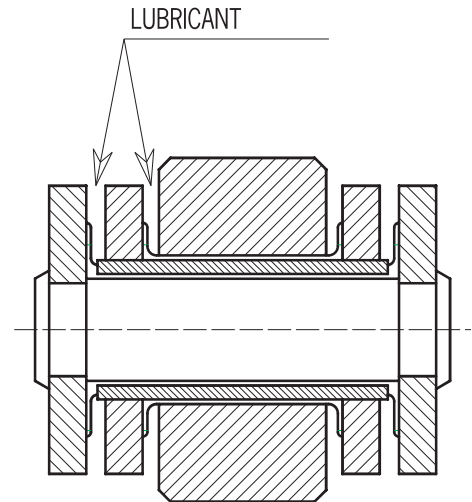

CONCLUSION

The lubrication discussion is by no means exhaustive, and is offered merely as a method of highlighting the importance of the correct lubrication of moving parts. Regretably, this subject is often either ignored or underestimated, but to ensure chain longevity, smooth and quiet running at minimum power consumption, it is crucial.

CHAIN IDENTIFICATION

To avoid misinterpretation, a standard terminology for chain identification is used. To demonstrate this terminology, the type of chain and the type of attachment are considered separately.

TYPE OF CHAIN

a) Each chain type is assigned a number, which identifies all the chain characteristics such as: pitch, internal width, roller diameter, etc.

Example:

Chain No. 352 - No. C2080H - No. 400C

b) The BS, metric M series DIN 8167 and FV series DIN 8165 chains are additionally identified by a letter (A) for the bush chain, (B) for the small roller, (C) for the large roller, or (D) for the flange roller and by a number which specifies chain pitch. (A single chain type can be almost any pitch).

Examples:

a) chain No. Z40-A-101,6

Z40	=	solid-pin chains, series BS 4116
A	=	bush chain
101,6	=	pitch of 101,6 mm.

b) chain No. MC112-D-200

MC112	=	chain with hollow pins, series DIN 8167
D	=	flange roller
200	=	pitch of 200 mm



c) Special chains not listed in the catalogue, are classified by pitch, internal width, roller diameter and the relevant design number.

Example:

chain pitch 150 X 23 X 45 in design n. 001954

Any deviation from the production standard must be followed by precisely defined characteristics.

Examples:

- a) chain N° 500 zinc-plated
- b) chain N° 500 with hardened and tempered plates
- c) chain N° 500 with 20 mm diameter rollers

TYPE OF ATTACHMENT

Attachments are defined by dimensional characteristics from a standard table or, in the case of special attachments, by a precisely detailed drawing.

The chain identifying code also includes the attachment code and specifies how the attachment is to be put into position, how many holes it must have, etc. as follows:

- A = for single-sided bent attachment
- M = for single-sided vertical attachment
- K = for double-sided bent attachment
- MK = for double-sided vertical attachment
- 1 = for single-holed attachment
- 2 = for double-holed attachment
- 3 = for triple-holed attachment
- 01 = for attachment every pitch
- 02 = for attachment every 2 pitches
- 10 = for attachment every 10 pitches
- 0X = for attachment every X pitches
- **ADDITIONAL ATTACHMENTS AVAILABLE ON REQUEST**

Examples:

- a) chain No. 500A202
chains type 500 single-sided attachments, with two holes, every 2 pitches
- b) chain No. 703K304
chain type 703, double-sided attachments, with 3 holes, every 4 pitches
- c) chain No. M160C125A203
chain series M ..., single-sided attachments, with 2 holes, every 3 pitches



Special attachments, or those which depart from the catalogue norm, are identified with the same classification criteria, but must always include the drawing number:

Example:

Chain No. 704A1-01, drawing N° 001988

When the attachments are required at even pitch intervals (02-04-06 etc.), they will be assembled on the external link of the chain unless otherwise specified.

The following pages illustrate the most common attachment assembly combinations.

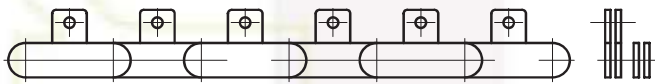

M1-01

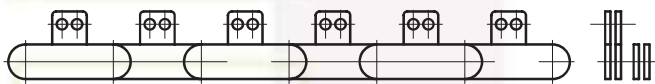

M2-01



M1-02



M2-02

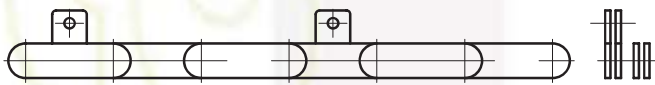

M1-03

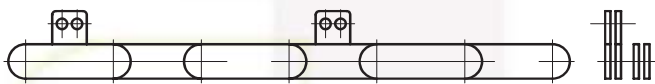

M2-03



M1-04

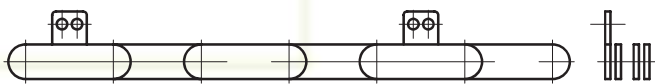

M2-04

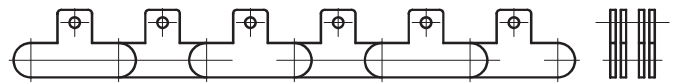

MK1-01

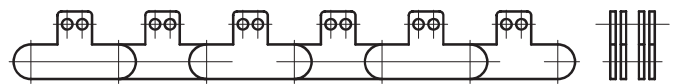

MK2-01

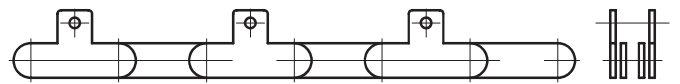

MK1-02



MK2-02

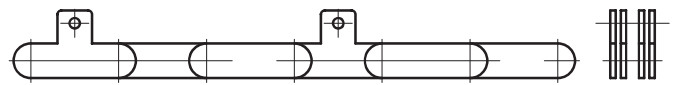

MK1-03

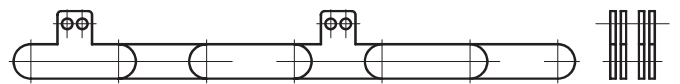

MK2-03

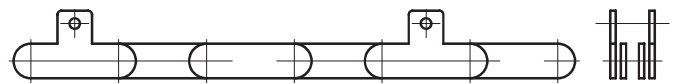

MK1-04

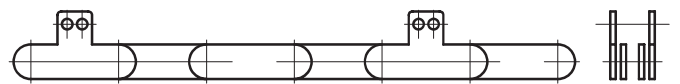

MK2-04



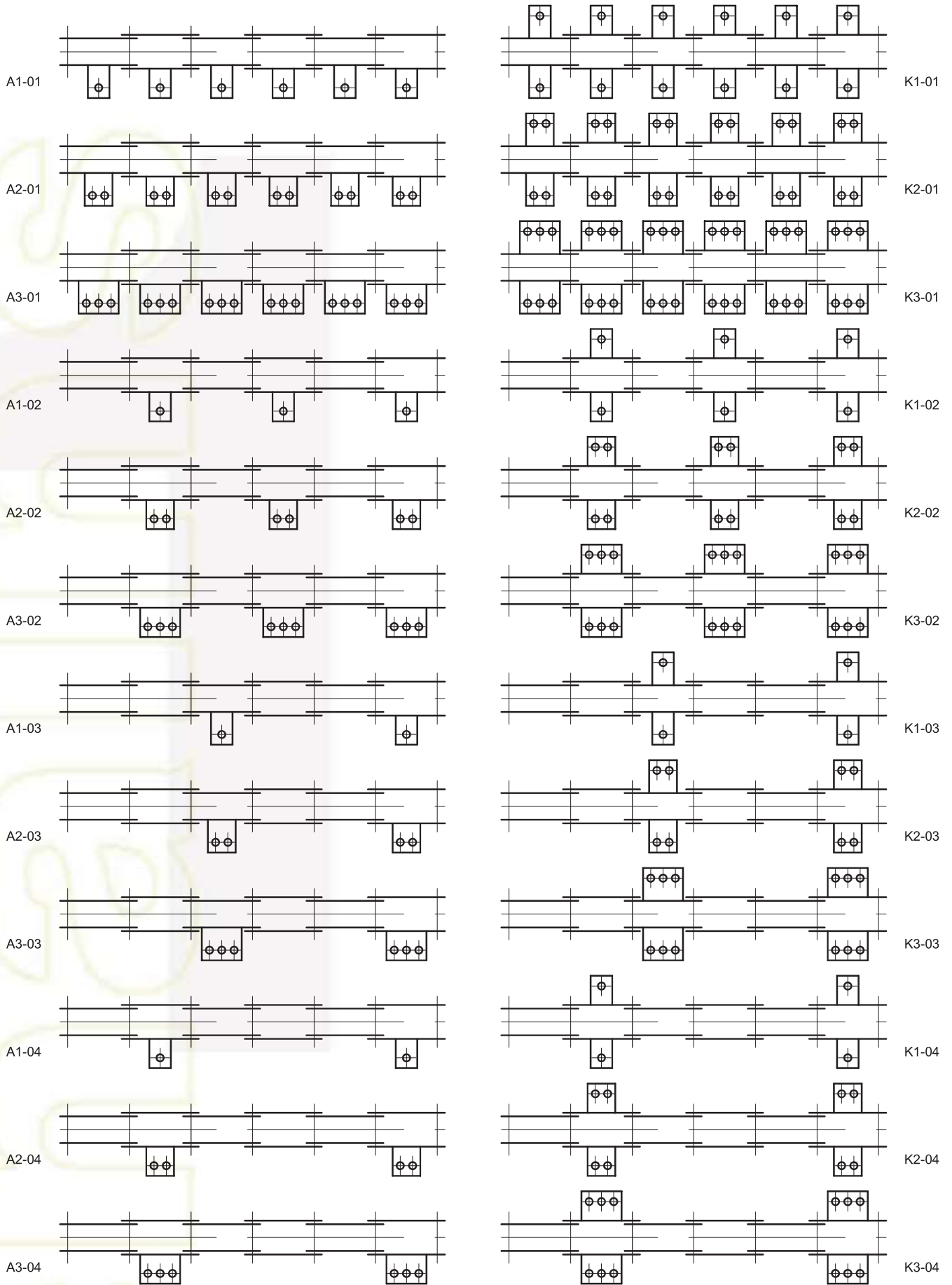

- ADDITIONAL ATTACHMENTS AVAILABLE ON REQUEST



CONVERSION FACTORS

Measure	LENGTH	multiplying by	to obtain	Measure
m	metre	39,3701	inch	in
m	metre	3,28084	foot	ft
m	metre	1,09361	yard	yd
cm	centimetre	0,393701	inch	in
cm	centimetre	0,032808	foot	ft
mm	millimetre	0,039370	inch	in
mm	millimetre	0,003280	foot	ft
in	inch	25,4	millimetre	mm
in	inch	2,54	centimetre	cm
in	inch	0,0254	metre	m
ft	foot	304,8	millimetre	mm
ft	foot	30,48	centimetre	cm
ft	foot	0,3048	metre	m
mi	mile	1,60934	kilometre	km
mi	mile	1609,344	metre	m
km	kilometre	0,621371	mile	mi
Measure	AREA	multiplying by	to obtain	Measure
m ²	square metre	1550	square inch	in ²
m ²	square metre	10,7639	square foot	ft ²
m ²	square metre	1,19599	yard square	yd ²
cm ²	square centimetre	0,001076	square foot	ft ²
cm ²	square centimetre	0,155	square inch	in ²
mm ²	square millimetre	0,00155	square inch	in ²
mm ²	square millimetre	0,000010 (1,07639x10 ⁻⁵)	square foot	ft ²
in ²	square inch	0,000645 (6,64516x10 ⁻⁴)	square metre	m ²
in ²	square inch	6,4516	square centimetre	cm ²
in ²	square inch	645,16	square millimetre	mm ²
ft ²	square foot	0,092903	square metre	m ²
ft ²	square foot	929,03	square centimetre	cm ²
ft ²	square foot	92903	square millimetre	mm ²
Measure	VOLUME	multiplying by	to obtain	Measure
m ³	cubic metre	61023,7	cubic inch	in ³
m ³	cubic metre	35,3147	cubic foot	ft ³
m ³	cubic metre	219,969	UK gallon (imperial)	UK gallon
m ³	cubic metre	264,172	USA gallon	gal (U.S. liquid)
l (dm ³)	litre	61,0237	cubic inch	in ³
l (dm ³)	litre	0,035314	cubic foot	ft ³
l (dm ³)	litre	0,219969	UK gallon (imperial)	UK gallon
l (dm ³)	litre	0,264172	USA gallon	gal (U.S. liquid)
cm ³	cubic centimetre	0,061023	cubic inch	in ³
cm ³	cubic centimetre	0,000035 (3,53147x10 ⁻⁵)	cubic foot	ft ³
ft ³	cubic foot	0,028316	cubic metre	m ³
ft ³	cubic foot	28,3168	litre	l (dm ³)
ft ³	cubic foot	28316,8	cubic centimetre	cm ³
in ³	cubic inch	0,000016 (1,63871x10 ⁻⁵)	cubic metre	m ³
in ³	cubic inch	0,016387	litre	l (dm ³)
in ³	cubic inch	16,3871	cubic centimetre	cm ³
UK gallon	UK gallon (imperial)	0,004546	cubic metre	m ³
UK gallon	UK gallon (imperial)	4,54609	litre	l (dm ³)
Measure	ANGLES	multiplying by	to obtain	Measure
°	degree (angle)	0,017453	radian	rad
rad	radian	57,2958	degree (angle)	°



CONVERSION FACTORS

Measure	TORQUE	multiplying by	to obtain	Measure
N m	newton metre	0,101972	kilogram-force metre	kgf m
N m	newton metre	0,737562	pound force foot	lbf ft
N m	newton metre	8,85075	pound force inch	lbf in
kgf m	kilogram-force metre	9,80665	newton metre	N m
kgf m	kilogram-force metre	7,23301	pound force foot	lbf ft
kgf m	kilogram-force metre	86,7962	pound force inch	lbf in
lbf in	pound force inch	0,112985	newton metre	N m
lbf in	pound force inch	0,0115212	kilogram-force metre	kgf m
lbf ft	pound force foot	1,35582	newton metre	N m
lbf ft	pound force foot	0,138255	kilogram-force metre	kgf m
Measure	FORCE AND WEIGHT FORCE	multiplying by	to obtain	Measure
N	newton	0,101972	kilogram force	kg
N	newton	0,224809	pound force	lbf
kgf	kilogram force	9,80665	newton	N
kgf	kilogram force	2,20462	pound force	lbf
lbf	pound force	4,44822	newton	N
lbf	pound force	0,453592	kilogram	kgf
ton f (UK)	ton-force UK	9964,02	newton	N
ton f (UK)	ton-force UK	1016,05	kilogram force	kgf
ton f (US)	ton-force US	8896,44	newton	N
ton f (US)	ton-force US	907,185	kilogram force	kgf
tf	ton-force metric	9806,65	newton	N
tf	ton-metric force	1000	kilogram-force	kgf
Measure	MASS/WEIGHT	multiplying by	to obtain	Measure
kg	kilogram	2,20462	pound	lb
kg	kilogram	0,000984 (9,84207x10 ⁻⁴)	ton UK (long ton)	ton UK
kg	kilogram	0,001102	ton US (short ton)	ton US
kg	kilogram	0,001	ton metric	t
lb	pound	0,453592	kilogram	kg
ton UK	ton UK (long ton)	1016,05	kilogram	kg
ton US	ton US (short ton)	907,185	kilogram	kg
t	ton metric	1000	kilogram	kg
Measure	DENSITY	multiplying by	to obtain	Measure
kg/m ³	kilogram per cubic metre	0,62428	pound per cubic foot	lb/ft ³
kg/m ³	kilogram per cubic metre	0,000036 (3,61273x10 ⁻⁵)	pound per cubic inch	lb/in ³
kg/m ³	kilogram per cubic metre	0,001	kilogram per litre	kg/l
lb/ft ³	pound per cubic foot	16,0185	kilogram per cubic metre	kg/m ³
lb/in ³	pound per cubic inch	27679,9	kilogram per cubic metre	kg/m ³
kg/l	kilogram per litre	1000	kilogram per cubic metre	kg/m ³
kg/l	kilogram per litre	62,428	pound per cubic foot	lb/ft ³
kg/l	kilogram per litre	0,036127	pound per cubic inch	lb/in ³
lb/ft ³	pound per cubic foot	0,016018	kilogram per litre	kg/l
lb/in ³	pound per cubic inch	27,6799	kilogram per litre	kg/l
Measure	WEIGHT FOR UNIT OF LENGTH	multiplying by	to obtain	Measure
kg/m	kilogram per metre	0,671972	pound per foot	lb/ft
lb/ft	pound per foot	0,13826	kilogram force per metre	kg/m
Measure	POWER	multiplying by	to obtain	Measure
Hp	horsepower	746	watt	W
CV	horsepower metric	735,499	watt	W
W	watt	0,001340	horsepower	Hp
W	watt	0,001359	horsepower metric	CV



CONVERSION FACTORS

Measure	POWER	multiplying by	to obtain	Measure
kW	kilowatt	1000	watt	W
kW	kilowatt	1,34048	horsepower	Hp
kW	kilowatt	1,35962	horsepower metric	CV
Hp	horsepower	0,746	kW kilowatt	kW
CV	horsepower metric	0,735499	kW kilowatt	kW
Measure	PRESSURE	multiplying by	to obtain	Measure
Pa (N/m ²)	pascal	0,0000010 (1,01972x10 ⁻⁷)	kilogram force per square millimetre	kgf/mm ²
Pa (N/m ²)	pascal	0,000010 (1,01972x10 ⁻⁵)	kilogram force per square centimetre	kgf/cm ²
Pa (N/m ²)	pascal	0,00001 (10 ⁻⁵)	bar	bar
Pa (N/m ²)	pascal	0,000009 (9,86923x10 ⁻⁶)	atmosphere	atm
Pa (N/m ²)	pascal	0,020885	pound per square foot	lbf/ft ²
Pa (N/m ²)	pascal	0,000145 (1,45038x10 ⁻⁴)	pound per square inch	lbf/in ² (psi)
Mpa (N/mm ²)	megapascal	0,101972	kilogram force per square millimetre	kgf/mm ²
Mpa (N/mm ²)	megapascal	10,1972	kilogram force per square centimetre	kgf/cm ²
Mpa (N/mm ²)	megapascal	10	bar	bar
Mpa (N/mm ²)	megapascal	9,86923	atmosphere	atm
Mpa (N/mm ²)	megapascal	20885,4	pound per square foot	lbf/ft ²
Mpa (N/mm ²)	megapascal	145,038	pound per square inch	lbf/in ² (psi)
kgf/cm ²	kilogram force per square centimetre	98066,5	pascal	Pa (N/m ²)
kgf/cm ²	kilogram force per square centimetre	0,098066	megapascal	Mpa (N/mm ²)
kgf/cm ²	kilogram force per square centimetre	14,2233	pound force per square foot	lbf/ft ² (psi)
kgf/cm ²	kilogram force per square centimetre	2048,16	pound force per square inch	lbf/ft ²
kgf/cm ²	kilogram force per square centimetre	0,980665	bar	bar
kgf/cm ²	kilogram force per square centimetre	0,967841	atmosphere	atm
kgf/mm ²	kilogram force per square millimetre	9806650	Pascal	Pa (N/m ²)
kgf/mm ²	kilogram force per square millimetre	9,80665	megapascal	Mpa (N/mm ²)
kgf/mm ²	kilogram force per square millimetre	1422,33	pound force per square inch	lbf/in ² (psi)
kgf/mm ²	kilogram force per square millimetre	204816	pound force per square foot	lbf/ft ²
kgf/mm ²	kilogram force per square millimetre	98,0665	bar	bar
kgf/mm ²	kilogram force per square millimetre	96,7841	atmosphere	atm
lbf/ft ²	pound force per square foot	47,8803	pascal	Pa (N/m ²)
lbf/ft ²	pound force per square foot	0,000047 (4,78803x10 ⁻⁵)	megapascal	Mpa (N/mm ²)
lbf/ft ²	pound force per square foot	0,000488	kilogram force per square centimetre	kgf/cm ²
lbf/ft ²	pound force per square foot	0,000004 (4,88243x10 ⁻⁶)	kilogram force per square millimetre	kgf/mm ²
lbf/ft ²	pound force per square foot	0,000478 (4,78803x10 ⁻⁴)	bar	bar
lbf/ft ²	pound force per square foot	0,000472 (4,72541x10 ⁻⁴)	atmosphere	atm
lbf/in ² (psi)	pound force per square inch	6894,76	pascal	Pa (N/m ²)
lbf/in ² (psi)	pound force per square inch	0,006894	megapascal	Mpa (N/mm ²)
lbf/in ² (psi)	pound force per square inch	0,070307	kilogram force per square centimetre	kgf/cm ²
lbf/in ² (psi)	pound force per square inch	0,000703 (7,0307x10 ⁻⁴)	kilogram force per square millimetre	kgf/mm ²
lbf/in ² (psi)	pound force per square inch	0,068947	bar	bar
lbf/in ² (psi)	pound force per square inch	0,068046	atmosphere	atm
bar	bar	100000	Pascal	Pa (N/m ²)
bar	bar	0,1	megapascal	Mpa (N/mm ²)
bar	bar	0,986923	atmosphere	atm
atm	atmosphere	101325	Pascal	Pa (N/m ²)
atm	atmosphere	0,101325	megapascal	Mpa (N/mm ²)
atm	atmosphere	1,01325	bar	bar
Measure	FLOW RATE BY MASS	multiplying by	to obtain	Measure
kg/sec	kilogram per second	60	kilogram per minute	kg/min
kg/sec	kilogram per second	3600	kilogram per hour	kg/h
kg/sec	kilogram per second	132,277	pound per minute	lb/min
kg/sec	kilogram per second	7936,64	pound per hour	lb/h
kg/sec	kilogram per second	3,6	ton per hour	t/h



CONVERSION FACTORS

Measure	FLOW RATE BY MASS	multiplying by	to obtain	Measure
kg/sec	kilogram per second	3,54314	British ton per hour	ton UK/h
kg/sec	kilogram per second	3,96832	ton USA per hour	ton US/h
kg/min	kilogram per minute	0,016666	kilogram per second	kg/sec
kg/h	kilogram per hour	0,000277 (2,77778x10 ⁻⁴)	kilogram per second	kg/sec
lb/min	pound per minute	0,00755987	kilogram per second	kg/sec
lb/h	pound per hour	0,000125 (1,25998x10 ⁻⁴)	kilogram per second	kg/sec
t/h	ton per hour	0,277778	kilogram per second	kg/sec
ton UK/h	British ton per hour	0,282235	kilogram per second	kg/sec
ton US/h	ton USA per hour	0,251996	kilogram per second	kg/sec
Measure	SPEED	multiplying by	to obtain	Measure
m/sec	metre per second	39,3701	inch per second	in/sec
m/sec	metre per second	2362,2	inch per minute	in/min
m/sec	metre per second	3,28084	foot per second	ft/sec
m/sec	metre per second	196,85	foot per minute	ft/min
m/sec	metre per second	3,6	kilometre per hour	km/h
m/sec	metre per second	2,23694	mile per hour	mi/h
m/min	metre per minute	0,016666	metre per second	m/sec
m/min	metre per minute	0,656168	inch per second	in/sec
m/min	metre per minute	39,3701	inch per minute	in/min
m/min	metre per minute	0,054680	foot per second	ft/sec
m/min	metre per minute	3,28084	foot per minute	ft/min
m/min	metre per minute	0,06	kilometre per hour	km/h
m/min	metre per minute	0,037282	mile per hour	mi/h
in/sec	inch per second	0,0254	metre per second	m/sec
in/min	inch per minute	0,000423 (4,23333x10 ⁻⁴)	metre per second	m/sec
ft/sec	foot per second	0,3048	metre per second	m/sec
ft/min	foot per minute	0,00508	metre per second	m/sec
km/h	kilometre per hour	0,2778	metre per second	m/sec
mi/h	mile per hour	0,44704	metre per second	m/sec
in/sec	inch per second	1,524	metre per minute	m/min
in/min	inch per minute	0,0254	metre per minute	m/min
ft/sec	foot per second	18,288	metre per minute	m/min
ft/min	foot per minute	0,3048	metre per minute	m/min
km/h	kilometre per hour	16,6667	metre per minute	m/min
mi/h	mile per hour	26,82240	metre per minute	m/min
Measure	TEMPERATURE	Applying the following formula	to obtain	Measure
°C	degrees Celsius	$(t_c \times 1,8) + 32$ t_c =temperature °C	degrees Fahrenheit	°F
°F	degrees Fahrenheit	$5/9 \times (t_f - 32)$ t_f =temperature °F	degrees Celsius	°C
K	kelvin	$t_k - 273,15$ t_k = temperature K	degrees Celsius	°C

