



## Produktprogramm

Product range



**WIPPERMANN**  
TRADING

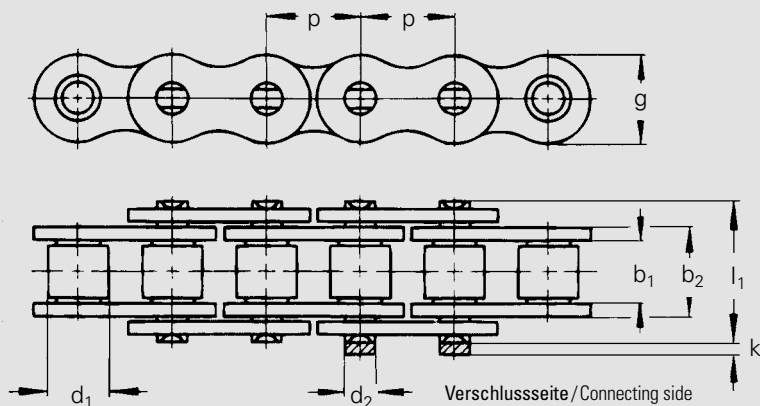

WITRA®		ISO	Teilung		Innere Breite	Innen-glied-breite	Rollen-Ø	Bolzen-Ø	Laschen-höhe	Über-stand	Maß über Bolzen	Gelenk-fläche	Bruchkraft ISO	Gewicht	Verbindungs-glieder
			Pitch		Inner width	Inner link width	Roller-Ø	Pin-Ø	Plate height	Project. over conn. link	Width over pin	Bear-ing area	Breaking load ISO	Weight	Connecting links
			p		b <sub>1</sub> min.	b <sub>2</sub> max.	d <sub>1</sub> max.	d <sub>2</sub> max.	g max.	k max.	l <sub>1</sub> max.	f	F <sub>B</sub> min.	q ≈	
No.	Ind.	No.	mm	inch	mm	mm	mm	mm	mm	mm	mm	cm <sup>2</sup>	N	kg/m	Type
WT 04		04	6,000	-	2,80	4,10	4,00	1,85	5,1	2,9	7,4	0,08	3 000	0,11	A, E, C
WT 05		05 B-1	8,000	-	3,00	4,77	5,00	2,31	7,1	3,1	8,6	0,11	5 000	0,18	A, E, C
WT 06	<sup>1</sup>	06 B-1	9,525	3/8	5,72	8,53	6,35	3,28	8,2	3,3	13,5	0,28	9 000	0,39	A, E, L, C
WT 08		08 B-1	12,700	1/2	7,75	11,30	8,51	4,45	11,8	3,9	17,0	0,50	18 000	0,68	A, E, L, C
WT 08	<sup>2</sup>	08 B-1	12,700	1/2	7,75	11,30	8,51	4,45	11,8	3,9	31,0	0,50	18 000	0,75	A, E, L
WT 081		081	12,700	1/2	3,30	5,80	7,75	3,66	9,9	1,5	10,2	0,21	8 200	0,28	A, E, L, C
WT 083		083	12,700	1/2	4,88	7,90	7,75	4,09	10,3	1,5	10,6	0,32	12 000	0,42	A, E, L
WT 084		084	12,700	1/2	4,88	8,80	7,75	4,09	11,1	1,5	11,5	0,36	16 000	0,59	A, E
WT 10		10 B-1	15,875	5/8	9,65	13,28	10,16	5,08	14,7	4,1	19,6	0,67	22 400	0,91	A, E, S, L, C
WT 12		12 B-1	19,050	3/4	11,68	15,62	12,07	5,72	16,1	4,6	22,7	0,89	29 000	1,12	A, E, S, L, C
WT 12-H		-	19,050	3/4	11,68	16,46	12,07	6,05	18,1	3,6	24,8	1,05	40 000	1,51	A, E, S, L
WT 16		16 B-1	25,400	1	17,02	25,40	15,88	8,28	21,0	5,4	36,1	2,10	60 000	2,64	A, E, S, L, C
WT 16-H		-	25,400	1	17,02	25,40	15,88	8,90	24,1	5,4	36,1	2,23	80 000	3,11	A, E, L
WT 20		20 B-1	31,750	1 1/4	19,56	29,00	19,05	10,19	26,4	6,1	43,2	2,96	95 000	3,68	A, E, S, L, C
WT 24		24 B-1	38,100	1 1/2	25,40	37,90	25,40	14,63	33,4	6,6	53,4	5,54	160 000	7,16	A, S, L, C
WT 28		28 B-1	44,450	1 3/4	30,99	46,50	27,94	15,90	37,0	7,4	65,1	7,39	200 000	7,53	A, S, L, C
WT 32		32 B-1	50,800	2	30,99	45,50	29,21	17,81	42,2	7,9	67,4	8,10	250 000	9,84	A, S, L, C
WT 40		40 B-1	63,500	2 1/2	38,10	55,70	39,37	22,89	52,9	10,0	82,6	12,75	355 000	16,99	A, S, L
WT 48		48 B-1	76,200	3	45,72	70,50	48,26	29,24	63,8	10,0	99,1	20,61	560 000	23,92	A, S, L
WT 56		56 B-1	88,900	3 1/2	53,34	81,30	53,98	34,32	77,8	11,7	114,6	27,90	850 000	35,78	A, S

<sup>1</sup> nur mit geraden Laschen / <sup>1</sup> with straight side plates only    <sup>2</sup> jeder 2. Bolzen als Duplexbolzen einseitig überstehend / <sup>2</sup> every 2<sup>nd</sup> pin as one-side duplex pin

#### Verbindungsglieder / Connecting links



**A**

Außenglied (Nietglied)

Pin link



**E**

Verbindungsglied mit Feder

Spring Connecting link



**S**

Verbindungsglied mit Splinten

Cotter pin Connecting link



**L**

Gekröpftes Glied mit Splint

Offset link



**C**

Gekröpftes Doppelglied

Double cranked link

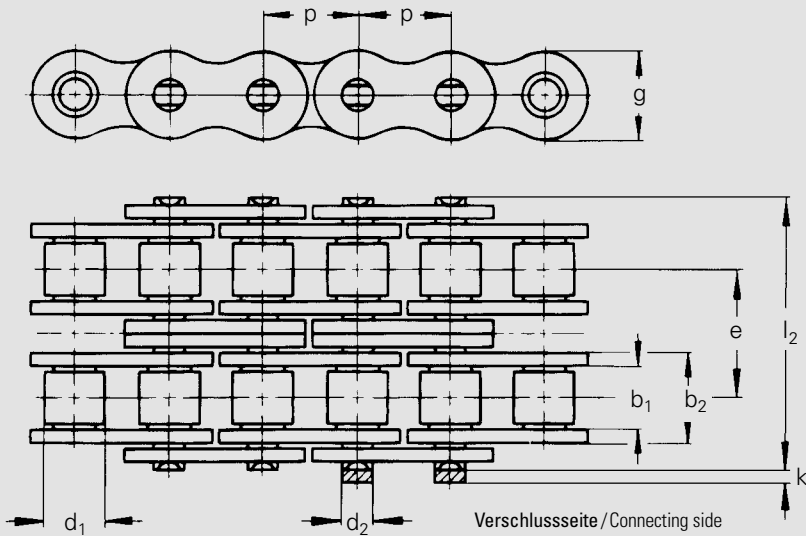

WITRA <sup>®</sup>		ISO	Teilung		Innere Breite	Innengliedbreite	Rollen-Ø	Bolzen-Ø	Quer-teilung	La-schen-höhe	Über-stand	Maß über Bolzen	Gelenk-fläche	Bruchkraft ISO	Gewicht	Verbindungs-glieder
			Pitch		Inner width	Inner link width	Roller-Ø	Pin-Ø	Trans-verse pitch	Plate height	Project. over conn. link	Width over pin	Bear-ing area	Breaking load ISO	Weight	Connecting links
			$p$		$b_1$ min.	$b_2$ max.	$d_1$ max.	$d_2$ max.	$e$	$g$ max.	$k$ max.	$l_2$ max.	$f$	$F_B$ min.	$q$ ≈	
No.	Ind.	No.	mm	inch	mm	mm	mm	mm	mm	mm	mm	mm	cm <sup>2</sup>	N	kg/m	Type
WT 05-D		05 B-2	8,000	-	3,00	4,77	5,00	2,31	5,64	7,1	3,1	14,3	0,22	7 800	0,34	A, E, C
WT 06-D	<sup>1</sup>	06 B-2	9,525	$\frac{3}{8}$	5,72	8,53	6,35	3,28	10,24	8,2	3,3	23,8	0,56	16 900	0,74	A, E, L, C
WT 08-D		08 B-2	12,700	$\frac{1}{2}$	7,75	11,30	8,51	4,45	13,92	11,8	3,9	31,0	1,01	32 000	1,35	A, E, L, C
WT 10-D		10 B-2	15,875	$\frac{5}{8}$	9,65	13,28	10,16	5,08	16,59	14,7	4,1	36,2	1,34	44 500	1,79	A, E, S, L, C
WT 12-D		12 B-2	19,050	$\frac{3}{4}$	11,68	15,62	12,07	5,72	19,46	16,1	4,6	42,2	1,79	57 800	2,22	A, E, S, L, C
WT 16-D		16 B-2	25,400	1	17,02	25,40	15,88	8,28	31,88	21,0	5,4	68,0	4,21	106 000	5,13	A, E, S, L, C
WT 16-D-H		-	25,400	1	17,02	25,40	15,88	8,90	31,88	24,1	5,4	68,0	4,46	150 000	6,14	A, E, L
WT 20-D		20 B-2	31,750	1 $\frac{1}{4}$	19,56	29,00	19,05	10,19	36,45	26,4	6,1	79,0	5,91	170 000	7,72	A, E, S, L, C
WT 24-D		24 B-2	38,100	1 $\frac{1}{2}$	25,40	37,90	25,40	14,63	48,36	33,4	6,6	101,4	11,09	280 000	14,15	A, S, L, C
WT 28-D		28 B-2	44,450	1 $\frac{3}{4}$	30,99	46,50	27,94	15,90	59,56	37,0	7,4	124,0	14,79	360 000	14,91	A, S, L, C
WT 32-D		32 B-2	50,800	2	30,99	45,50	29,21	17,81	58,55	42,2	7,9	126,0	16,21	450 000	19,68	A, S, L, C
WT 40-D		40 B-2	63,500	2 $\frac{1}{2}$	38,10	55,70	39,37	22,89	72,29	52,9	10,0	154,0	25,50	630 000	33,61	A, S, L
WT 48-D		48 B-2	76,200	3	45,72	70,50	48,26	29,24	91,21	63,8	10,0	190,4	41,23	1 000 000	47,50	A, S, L
WT 56-D		56 B-2	88,900	3 $\frac{1}{2}$	53,34	81,30	53,98	34,32	106,60	77,8	11,7	221,2	55,80	1 600 000	71,48	A, S

<sup>1</sup> nur mit geraden Laschen / <sup>1</sup> with straight side plates only

Verbindungsglieder / Connecting links



**A**

Außenglied (Nietglied)

Pin link



**E**

Verbindungsglied mit Feder

Spring Connecting link



**S**

Verbindungsglied mit Splinten

Cotter pin Connecting link



**L**

Gekröpftes Glied mit Splint

Offset link



**C**

Gekröpftes Doppelglied

Double cranked link

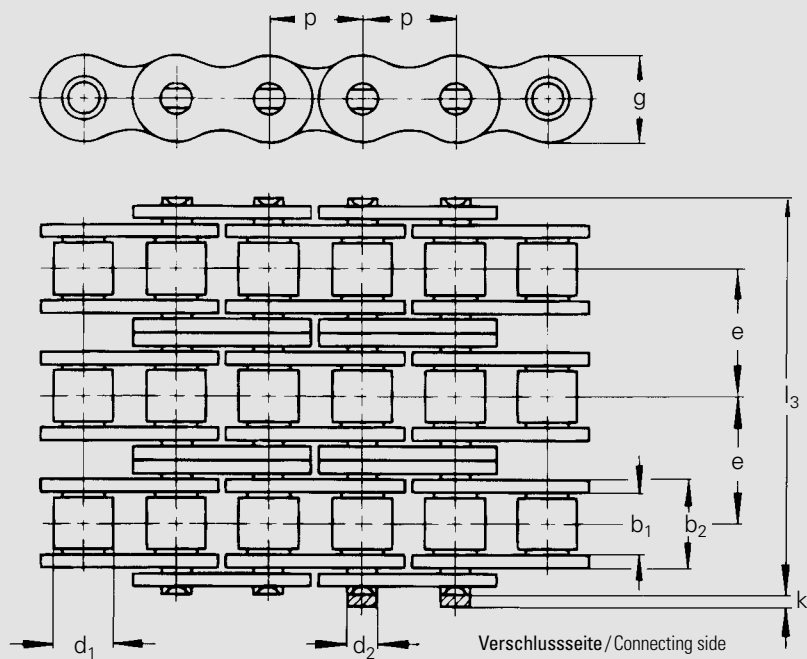

WITRA®		ISO	Teilung		Innere Breite	Innengliedbreite	Rollen-Ø	Bolzen-Ø	Quer-teilung	La-schen-höhe	Über-stand	Maß über Bolzen	Gelenk-fläche	Bruchkraft ISO	Gewicht	Verbindungs-glieder
No.	Ind.	No.	mm	inch	Inner width	Inner link width	Roller-Ø	Pin-Ø	Transverse pitch	Plate height	Project. over conn. link	Width over pin	Bearing area	Breaking load ISO	Weight	Connecting links
			$p$		$b_1$ min.	$b_2$ max.	$d_1$ max.	$d_2$ max.	$e$	$g$ max.	$k$ max.	$l_3$ max.	$f$	$F_B$ min.	$q$ ≈	Type
WT 06-T	<sup>1</sup>	06 B-3	9,525	3/8	5,72	8,53	6,35	3,28	10,24	8,2	3,3	34,0	0,81	23 600	1,10	A, E, L, C
WT 08-T		08 B-3	12,700	1/2	7,75	11,30	8,51	4,45	13,92	11,8	3,9	44,9	1,51	47 500	2,03	A, E, L, C
WT 10-T		10 B-3	15,875	5/8	9,65	13,28	10,16	5,08	16,59	14,7	4,1	52,8	2,02	66 700	2,68	A, E, S, L, C
WT 12-T		12 B-3	19,050	3/4	11,68	15,62	12,07	5,72	19,46	16,1	4,6	61,7	2,68	86 700	3,39	A, E, S, L, C
WT 16-T		16 B-3	25,400	1	17,02	25,40	15,88	8,28	31,88	21,0	5,4	99,9	6,31	160 000	7,80	A, E, S, L, C
WT-C 16-T	<sup>1</sup>	16 B-3	25,400	1	17,02	25,40	15,88	8,28	31,88	21,0	5,4	99,9	6,31	160 000	9,12	A, E, S, L, C
WT 20-T		20 B-3	31,750	1 1/4	19,56	29,00	19,05	10,19	36,45	26,4	6,1	116,0	8,87	250 000	11,53	A, S, L, C
WT 24-T		24 B-3	38,100	1 1/2	25,40	37,90	25,40	14,63	48,36	33,4	6,6	150,0	16,63	425 000	21,15	A, S, L, C
WT 28-T		28 B-3	44,450	1 3/4	30,99	46,50	27,94	15,90	59,56	37,0	7,4	184,0	22,18	530 000	22,39	A, S, L, C
WT 32-T		32 B-3	50,800	2	30,99	45,50	29,21	17,81	58,55	42,2	7,9	184,0	24,31	670 000	29,52	A, S, L, C
WT 40-T		40 B-3	63,500	2 1/2	38,10	55,70	39,37	22,89	72,29	52,9	10,0	227,0	38,25	950 000	50,23	A, S, L
WT 48-T		48 B-3	76,200	3	45,72	70,50	48,26	29,24	91,21	63,8	10,0	281,0	61,84	1 500 000	71,07	A, S, L
WT 56-T		56 B-3	88,900	3 1/2	53,34	81,30	53,98	34,32	106,60	77,8	11,7	327,8	83,70	2 240 000	107,18	A, S

<sup>1</sup> nur mit geraden Laschen / <sup>1</sup> with straight side plates only

### Verbindungsglieder / Connecting links



**A**

Außenglied  
(Nietglied)

Pin link



**E**

Verbindungsglied  
mit Feder

Spring  
Connecting link



**S**

Verbindungsglied  
mit Splinten

Cotter pin  
Connecting link



**L**

Gekröpftes Glied  
mit Splint

Offset link



**C**

Gekröpftes  
Doppelglied

Double  
cranked link

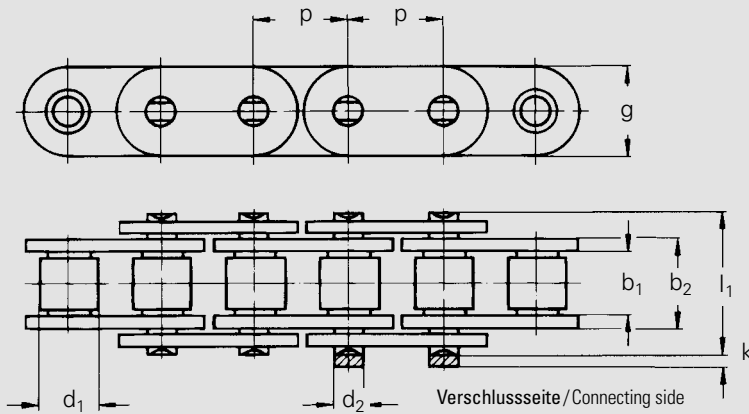

WITRA <sup>®</sup>	ISO	Teilung		Innere Breite	Innen-glied-breite	Rollen-Ø	Bolzen-Ø	Laschen-höhe	Über-stand	Maß über Bolzen	Gelenk-fläche	Bruchkraft ISO	Gewicht	Verbindungs-glieder
		Pitch		Inner width	Inner link width	Roller-Ø	Pin-Ø	Plate height	Project. over conn. link	Width over pin	Bear-ing area	Breaking load ISO	Weight	Connecting links
		p		b <sub>1</sub> min.	b <sub>2</sub> max.	d <sub>1</sub> max.	d <sub>2</sub> max.	g max.	k max.	l <sub>1</sub> max.	f	F <sub>B</sub> min.	q ≈	
No.	No.	mm	inch	mm	mm	mm	mm	mm	mm	mm	cm <sup>2</sup>	N	kg/m	Type
WT C 08	C 08 B-1	12,700	½	7,75	11,30	8,51	4,45	11,8	3,9	17,0	0,50	18 000	0,68	A, E, L
WT C 10	C 10 B-1	15,875	⅝	9,65	13,28	10,16	5,08	14,7	4,1	19,6	0,67	22 400	0,91	A, E, L
WT C 12	C 12 B-1	19,050	¾	11,68	15,62	12,07	5,72	16,1	4,6	22,7	0,89	29 000	1,12	A, E, L
WT C 16	C 16 B-1	25,400	1	17,02	25,40	15,88	8,28	21,0	5,4	36,1	2,10	60 000	2,64	A, E, S, L
WT C 16/24	-	25,400	1	17,02	25,40	15,88	8,28	24,0	5,4	36,1	2,10	60 000	2,64	A, E
WT C 20	C 20 B-1	31,750	1 ¼	19,56	29,00	19,05	10,19	26,4	6,1	43,2	2,96	95 000	3,68	A, E, S, L
WT C 24	C 24 B-1	38,100	1 ½	25,40	37,90	25,40	14,63	33,4	6,6	53,4	5,54	160 000	7,16	A, S, L
WT C 32	C 32 B-1	50,800	2	30,99	45,50	29,21	17,81	42,2	7,9	67,4	8,10	250 000	9,84	A, S, L

Verbindungs-glieder / Connecting links



**A**

Außenglied  
(Nietglied)

Pin link



**E**

Verbindungs-glied  
mit Feder

Spring  
Connecting link



**S**

Verbindungs-glied  
mit Splinten

Cotter pin  
Connecting link



**L**

Gekröpftes Glied  
mit Splint

Offset link

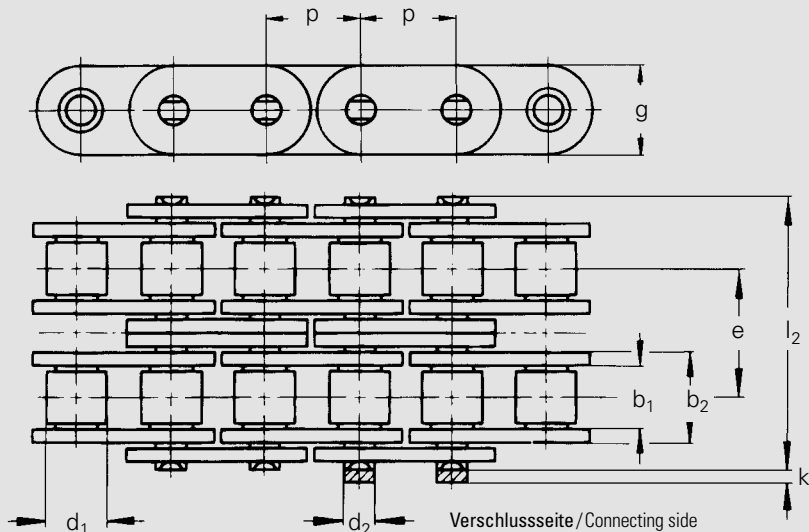

WITRA®	ISO	Teilung		Innere Breite	Innengliedbreite	Rollen-Ø	Bolzen-Ø	Querteilung	Laschenhöhe	Überstand	Maß über Bolzen	Gelenkfläche	Bruchkraft ISO	Gewicht	Verbindungsglieder
No.	No.	mm	inch	mm	mm	mm	mm	mm	mm	mm	mm	cm <sup>2</sup>	N	kg/m	Type
WT C 06-D	C 06 B-2	9,525	3/8	5,72	8,53	6,35	3,28	10,24	8,2	3,3	23,8	0,56	16 900	0,74	A, E, L
WT C 08-D	C 08 B-2	12,700	1/2	7,75	11,30	8,51	4,45	13,92	11,8	3,9	31,0	1,01	32 000	1,35	A, E, L
WT C 10-D	C 10 B-2	15,875	5/8	9,65	13,28	10,16	5,08	16,59	14,7	4,1	36,2	1,34	44 500	1,79	A, E, L
WT C 12-D	C 12 B-2	19,050	3/4	11,68	15,62	12,07	5,72	19,46	16,1	4,6	42,2	1,79	57 800	2,22	A, E, S, L
WT C 16-D	C 16 B-2	25,400	1	17,02	25,40	15,88	8,28	31,88	21,0	5,4	68,0	4,21	106 000	5,13	A, E, S, L
WT C 20-D	C 20 B-2	31,750	1 1/4	19,56	29,00	19,05	10,19	36,45	26,4	6,1	79,0	5,91	170 000	7,72	A, E, S, L
WT C 24-D	C 24 B-2	38,100	1 1/2	25,40	37,90	25,40	14,63	48,36	33,4	6,6	101,4	11,09	280 000	14,15	A, S, L
WT C 32-D	C 32 B-2	50,800	2	31,55	45,00	28,58	14,27	58,55	48,2	7,9	124,0	12,84	453 600	19,00	A, S, L

### Verbindungsglieder / Connecting links



**A**

Außenglied  
(Nietglied)

Pin link



**E**

Verbindungsglied  
mit Feder

Spring  
Connecting link



**S**

Verbindungsglied  
mit Splinten

Cotter pin  
Connecting link



**L**

Gekröpftes Glied  
mit Splint

Offset link

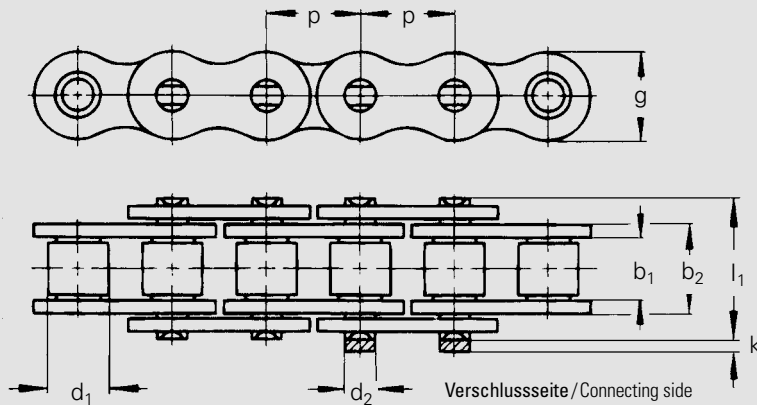

WITRA <sup>®</sup>		ISO	Teilung		Innere Breite	Innengliedbreite	Rollen-Ø	Bolzen-Ø	Laschenhöhe	Überstand	Maß über Bolzen	Gelenkfläche	Bruchkraft ISO	Gewicht	Verbindungsglieder
			Pitch		Inner width	Inner link width	Roller-Ø	Pin-Ø	Plate height	Project. over conn. link	Width over pin	Bearing area	Breaking load ISO	Weight	Connecting links
			p		b <sub>1</sub> min.	b <sub>2</sub> max.	d <sub>1</sub> max.	d <sub>2</sub> max.	g max.	k max.	l <sub>1</sub> max.	f	F <sub>B</sub> min.	q ≈	
No.	Ind.	No.	mm	inch	mm	mm	mm	mm	mm	mm	mm	cm <sup>2</sup>	N	kg/m	Type
WT ASA 40		08 A-1	12,700	1/2	7,85	11,15	7,95	3,96	12,0	3,9	17,8	0,44	14 100	0,60	A, E, L, C
WT ASA 50		10 A-1	15,875	5/8	9,40	13,80	10,16	5,08	15,0	4,1	21,8	0,70	22 200	1,04	A, E, L, C
WT ASA 60		12 A-1	19,050	3/4	12,57	17,70	11,91	5,94	18,0	4,6	26,9	1,05	31 800	1,52	A, E, S, L, C
WT ASA 60-GL	<sup>1</sup>	C12 A-1	19,050	3/4	12,57	17,70	11,91	5,94	18,0	4,6	26,9	1,05	31 800	1,58	A, E, L, C
WT ASA 80		16 A-1	25,400	1	15,75	22,50	15,88	7,92	24,1	5,4	33,5	1,78	56 700	2,60	A, E, S, L, C
WT ASA 100		20 A-1	31,750	1 1/4	18,90	27,40	19,05	9,53	30,1	6,1	41,1	2,61	88 500	4,01	A, S, L
WT ASA 120		24 A-1	38,100	1 1/2	25,22	35,30	22,23	11,10	36,2	6,6	50,8	3,92	127 000	5,74	A, S, L
WT ASA 140		28 A-1	44,450	1 3/4	25,22	37,00	25,40	12,70	42,2	7,4	54,9	4,70	172 400	7,66	A, S, L
WT ASA 160		32 A-1	50,800	2	31,55	45,00	28,58	14,27	48,2	7,9	65,5	6,42	226 800	9,84	A, S, L

<sup>1</sup> nur mit geraden Laschen / <sup>1</sup> with straight side plates only

Verbindungsglieder / Connecting links



**A**

Außenglied  
(Nietglied)

Pin link



**E**

Verbindungsglied  
mit Feder

Spring  
Connecting link



**S**

Verbindungsglied  
mit Splinten

Cotter pin  
Connecting link



**L**

Gekrüpfes Glied  
mit Splint

Offset link



**C**

Gekrüpfes  
Doppelglied

Double  
cranked link

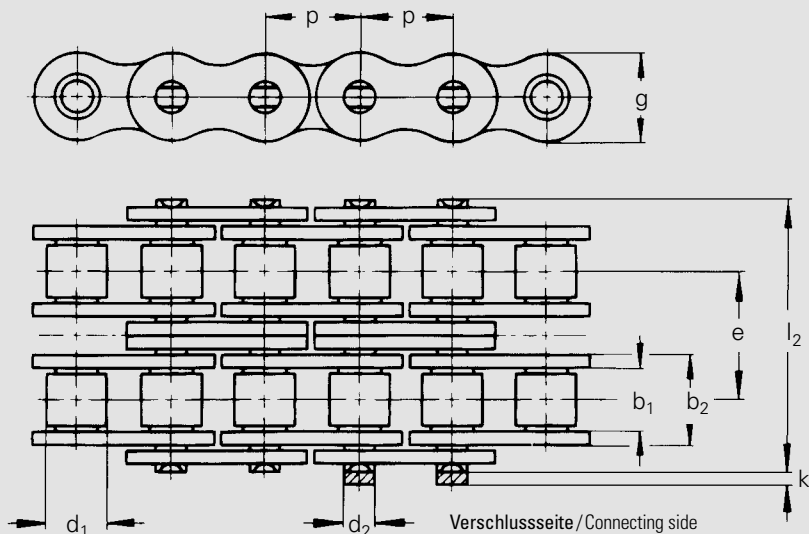

WITRA®	ISO	Teilung		Innere Breite	Innengliedbreite	Rollen-Ø	Bolzen-Ø	Quer- teilung	La- schen- höhe	Über- stand	Maß über Bolzen	Gelenk- fläche	Bruchkraft ISO	Gewicht	Verbindungs- glieder
No.	No.	mm	inch	Inner width	Inner link width	Roller- Ø	Pin- Ø	Trans- verse pitch	Plate height	Project. over conn. link	Width over pin	Bear- ing area	Breaking load ISO	Weight	Connecting links
		p		b <sub>1</sub> min.	b <sub>2</sub> max.	d <sub>1</sub> max.	d <sub>2</sub> max.	e	g max.	k max.	l <sub>2</sub> max.	f	F <sub>B</sub> min.	q ≈	Type
WT ASA 40-D	08 A-2	12,700	1/2	7,85	11,15	7,95	3,96	14,38	12,0	3,9	32,3	0,88	28 200	1,20	A, E, L, C
WT ASA 50-D	10 A-2	15,875	5/8	9,40	13,80	10,16	5,08	18,11	15,0	4,1	39,9	1,40	44 400	1,78	A, E, L, C
WT ASA 60-D	12 A-2	19,050	3/4	12,57	17,70	11,91	5,94	22,78	18,0	4,6	49,8	2,10	63 600	3,01	A, E, L, C
WT ASA 80-D	16 A-2	25,400	1	15,75	22,50	15,88	7,92	29,29	24,1	5,4	62,7	3,56	113 400	5,15	A, E, L, C
WT ASA 100-D	20 A-2	31,750	1 1/4	18,90	27,40	19,05	9,53	35,76	30,1	6,1	77,0	5,22	177 000	7,93	A, S, L
WT ASA 120-D	24 A-2	38,100	1 1/2	25,22	35,30	22,23	11,10	45,44	36,2	6,6	96,3	7,84	254 000	11,37	A, S, L
WT ASA 140-D	28 A-2	44,450	1 3/4	25,22	37,00	25,40	12,70	48,87	42,2	7,4	103,6	9,40	344 800	15,36	A, S, L
WT ASA 160-D	32 A-2	50,800	2	31,55	45,00	28,58	14,27	58,55	48,2	7,9	124,2	12,84	453 600	19,53	A, S, L

### Verbindungsglieder / Connecting links



**A**

Außenglied  
(Nietglied)

Pin link



**E**

Verbindungsglied  
mit Feder

Spring  
Connecting link



**S**

Verbindungsglied  
mit Splinten

Cotter pin  
Connecting link



**L**

Gekröpftes Glied  
mit Splint

Offset link



**C**

Gekröpftes  
Doppelglied

Double  
cranked link



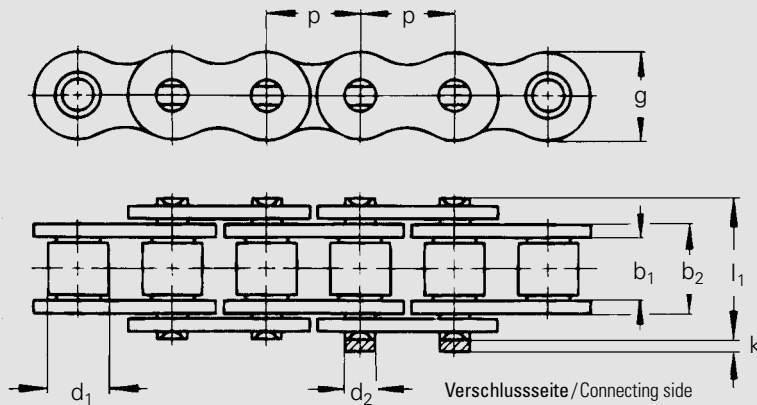

WITRA <sup>®</sup>		Teilung		Innere Breite	Innengliedbreite	Rollen-Ø	Bolzen-Ø	Laschenhöhe	Überstand	Maß über Bolzen	Gelenkfläche	Bruchkraft ISO	Gewicht	Verbindungsglieder
		Pitch		Inner width	Inner link width	Roller-Ø	Pin-Ø	Plate height	Project. over conn. link	Width over pin	Bearing area	Breaking load ISO	Weight	Connecting links
		p		b <sub>1</sub> min.	b <sub>2</sub> max.	d <sub>1</sub> max.	d <sub>2</sub> max.	g max.	k max.	l <sub>1</sub> max.	f	F <sub>B</sub> min.	q ≈	
No.	Ind.	mm	inch	mm	mm	mm	mm	mm	mm	mm	cm <sup>2</sup>	N	kg/m	Type
WT ASA 50-H		15,875	5/8	9,40	14,24	10,16	5,08	15,0	4,1	22,1	0,74	22 200	1,25	A, E, L
WT ASA 60-H		19,050	3/4	12,57	19,43	11,91	5,96	18,0	4,6	30,2	1,16	31 300	1,81	A, E, L
WT ASA 80-H		25,400	1	15,75	24,28	15,88	7,94	24,1	5,4	37,4	1,92	55 600	3,00	A, E, L
WT ASA 100-H		31,750	1 1/4	18,90	29,10	19,05	9,54	30,1	6,1	44,5	2,77	87 000	4,38	A, S, L
WT ASA 120-H		38,100	1 1/2	25,22	37,18	22,23	11,11	36,2	6,6	55,0	4,13	125 000	6,61	A, S, L
WT ASA 140-H		44,450	1 3/4	25,22	38,86	25,40	12,71	42,2	7,4	59,0	4,94	170 000	8,33	A, S, L
WT ASA 60-HGL	<sup>1</sup>	19,050	3/4	12,57	19,43	11,91	5,96	18,0	4,6	30,2	1,16	31 300	1,81	A, E, L
WT ASA 80-HGL	<sup>1</sup>	25,400	1	15,75	24,28	15,88	7,94	24,1	5,4	37,4	1,92	55 600	3,00	A, E, L

<sup>1</sup> nur mit geraden Laschen / <sup>1</sup> with straight side plates only

Verbindungsglieder / Connecting links



**A**

Außenglied  
(Nietglied)

Pin link



**E**

Verbindungsglied  
mit Feder

Spring  
Connecting link



**S**

Verbindungsglied  
mit Splinten

Cotter pin  
Connecting link



**L**

Gekröpftes Glied  
mit Splint

Offset link

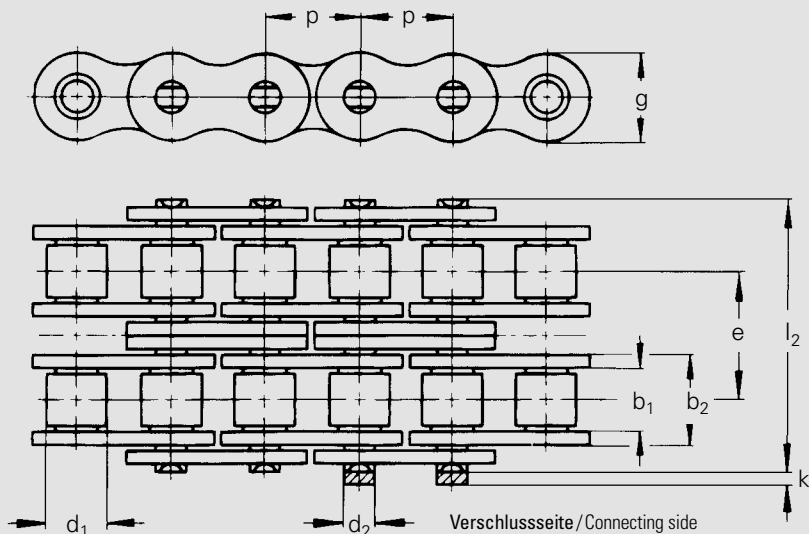

WITRA®	Teilung		Innere Breite	Innengliedbreite	Rollen-Ø	Bolzen-Ø	Quer- teilung	La- schen- höhe	Über- stand	Maß über Bolzen	Gelenk- fläche	Bruchkraft ISO	Gewicht	Verbindungs- glieder
	Pitch		Inner width	Inner link width	Roller- Ø	Pin- Ø	Trans- verse pitch	Plate height	Project. over conn. link	Width over pin	Bear- ing area	Breaking load ISO	Weight	Connecting links
	$p$		$b_1$ min.	$b_2$ max.	$d_1$ max.	$d_2$ max.	$e$	$g$ max.	$k$ max.	$l_2$ max.	$f$	$F_B$ min.	$q$ ≈	
No.	mm	inch	mm	mm	mm	mm	mm	mm	mm	mm	cm <sup>2</sup>	N	kg/m	Type
WT ASA 60-H-2	19,05	¾	12,57	19,43	11,91	5,96	26,11	18,1	4,6	56,3	2,27	62 600	3,71	A, E, L
WT ASA 80-H-2	25,40	1	15,75	24,28	15,88	7,94	32,59	24,1	5,4	70,0	3,79	112 200	5,93	A, E, L
WT ASA 100-H-2	31,75	1¼	18,90	29,10	19,05	9,54	39,09	30,2	6,1	83,6	5,50	174 000	8,67	A, S, L
WT ASA 120-H-2	38,10	1½	25,22	37,18	22,23	11,11	48,87	36,2	6,6	103,9	8,20	250 000	13,13	A, S, L
WT ASA 140-H-2	44,45	1¾	25,22	38,86	25,40	12,71	52,20	42,2	7,4	111,2	9,35	340 000	16,51	A, S, L

### Verbindungsglieder / Connecting links



**A**

Außenglied  
(Nietglied)

Pin link



**E**

Verbindungsglied  
mit Feder

Spring  
Connecting link



**S**

Verbindungsglied  
mit Splinten

Cotter pin  
Connecting link



**L**

Gekröpftes Glied  
mit Splint

Offset link

# Rollenketten „rostfrei“ - Rollenketten Reihe C „rostfrei“

Roller chains „stainless steel“ - Roller chains with straight side plates „stainless steel“

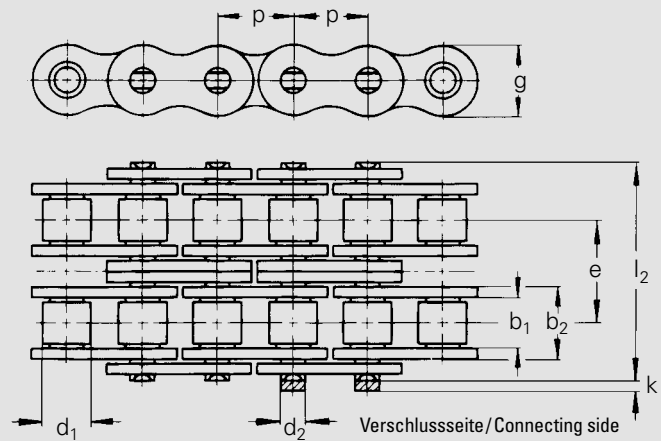
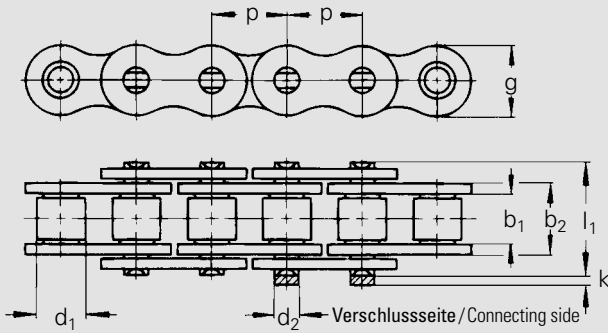

WITRA <sup>®</sup>	ISO	Teilung		Innere Breite	Innengliedbreite	Rollen-Ø	Bolzen-Ø	Quer- teilung	La- schen- höhe	Über- stand	Maß über Bolzen	Gelenk- fläche	Bruch- kraft ISO	Gewicht	Verbindungs- glieder
No.	No.	mm	inch	mm	mm	mm	mm	mm	mm	mm	mm	cm <sup>2</sup>	N	kg/m	Connecting links
		Pitch		Inner width	Inner link width	Roller- Ø	Pin- Ø	Trans- verse pitch	Plate height	Project. over conn. link	Width over pin	Bear- ing area	Breaking load ISO	Weight	Connecting links
		p		b <sub>1</sub> min.	b <sub>2</sub> max.	d <sub>1</sub> max.	d <sub>2</sub> max.	e	g max.	k max.	l max.	f	F <sub>B</sub> min.	q ≈	Type
WT 05 SS	05 B-1	8,000	-	3,00	4,77	5,00	2,31	-	7,1	3,1	8,6	0,11	5 000	0,18	A, E, C
WT 06 SS	06 B-1	9,525	3/8	5,72	8,53	6,35	3,28	-	8,2	3,3	13,5	0,28	9 000	0,41	A, E, L, C
WT 08 SS	08 B-1	12,700	1/2	7,75	11,30	8,51	4,45	-	11,8	3,9	17,0	0,50	12 000	0,68	A, E, L, C
WT 10 SS	10 B-1	15,875	5/8	9,65	13,28	10,16	5,08	-	14,7	4,1	19,6	0,67	15 000	0,91	A, E, L, C
WT 12 SS	12 B-1	19,050	3/4	11,68	15,62	12,07	5,72	-	16,1	4,6	22,7	0,88	17 000	1,12	A, E, L, C
WT 16 SS	16 B-1	25,400	1	17,02	25,40	15,88	8,27	-	21,0	5,4	36,1	2,07	40 000	2,64	A, E, S, L, C
WT 06-D SS	06 B-2	9,525	3/8	5,72	8,53	6,35	3,28	10,24	8,2	3,3	23,8	0,56	16 900	0,78	A, E, L, C
WT 08-D SS	08 B-2	12,700	1/2	7,75	11,30	8,51	4,45	13,92	11,8	3,9	31,0	1,00	22 000	1,35	A, E, L, C
WT 10-D SS	10 B-2	15,875	5/8	9,65	13,28	10,16	5,08	16,59	14,7	4,1	36,2	1,34	28 400	1,79	A, E, L, C
WT 12-D SS	12 B-2	19,050	3/4	11,68	15,62	12,07	5,72	19,46	16,1	4,6	42,2	1,76	37 200	2,22	A, E, L, C
WT 16-D SS	16 B-2	25,400	1	17,02	25,40	15,88	8,27	31,88	21,0	5,4	68,0	4,14	74 400	5,13	A, E, S, L, C

## Einfach Rollenketten Reihe C „rostfrei“ (gerade Laschen) Simplex roller chains with straight side plates „stainless steel“

WT C 08 SS	08 B-1	12,700	1/2	7,75	11,30	8,51	4,45	-	11,8	3,9	17,0	0,50	12 000	0,68	A, E, L
WT C 10 SS	10 B-1	15,875	5/8	9,65	13,28	10,16	5,08	-	14,7	4,1	19,1	0,67	15 000	0,91	A, E, L
WT C 12 SS	12 B-1	19,050	3/4	11,68	15,62	12,07	5,72	-	16,1	4,6	22,7	0,88	17 000	1,12	A, E, L
WT C 16 SS	16 B-1	25,400	1	17,02	25,40	15,88	8,27	-	21,0	5,4	36,1	2,07	40 000	2,64	A, E, L
WT C 16 SS/24	-	25,400	1	17,02	25,40	15,88	8,27	-	24,0	5,4	36,1	2,07	40 000	2,64	A, E

## Verbindungsglieder / Connecting links

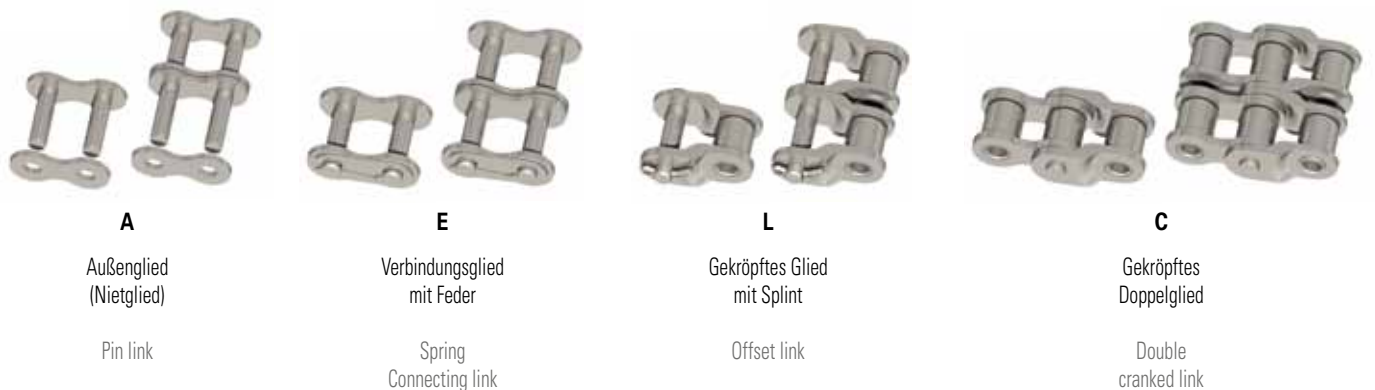

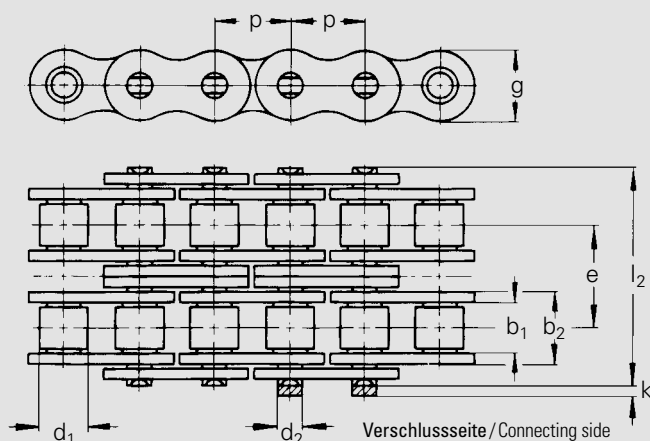
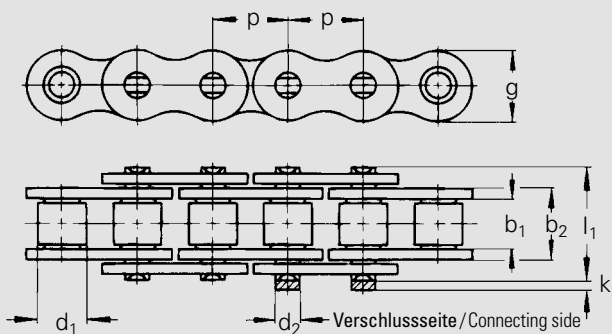

WITRA®	ISO	Teilung		Innere Breite	Innengliedbreite	Rollen-Ø	Bolzen-Ø	Quer- teilung	La- schen- höhe	Über- stand	Maß über Bolzen	Gelenk- fläche	Bruch- kraft ISO	Gewicht	Verbindungs- glieder
		Pitch		Inner width	Inner link width	Roller- Ø	Pin- Ø	Trans- verse pitch	Plate height	Project. over conn. link	Width over pin	Bea- ring area	Breaking load ISO	Weight	Connecting links
		p		b <sub>1</sub> min.	b <sub>2</sub> max.	d <sub>1</sub> max.	d <sub>2</sub> max.	e	g max.	k max.	l max.	f	F <sub>B</sub> min.	q ≈	Type
No.	No.	mm	inch	mm	mm	mm	mm	mm	mm	mm	mm	cm <sup>2</sup>	N	kg/m	
WT 05 NP	05 B-1	8,000	-	3,00	4,77	5,00	2,31	-	7,1	3,1	8,6	0,11	5 000	0,18	A, E
WT 06 NP	06 B-1	9,525	3/8	5,72	8,53	6,35	3,28	-	8,2	3,3	13,5	0,28	9 000	0,39	A, E, L
WT 08 NP	08 B-1	12,700	1/2	7,75	11,30	8,51	4,45	-	11,8	3,9	17,0	0,50	18 000	0,68	A, E, L
WT 10 NP	10 B-1	15,875	5/8	9,65	13,28	10,16	5,08	-	14,7	4,1	19,6	0,67	22 400	0,91	A, E, L
WT 12 NP	12 B-1	19,050	3/4	11,68	15,62	12,07	5,72	-	16,1	4,6	22,7	0,89	29 000	1,12	A, E, L
WT 16 NP	16 B-1	25,400	1	17,02	25,40	15,88	8,28	-	21,0	5,4	36,1	2,10	60 000	2,64	A, E, L
WT 05-D NP	05 B-2	8,000	-	3,00	4,77	5,00	2,31	5,64	7,1	3,1	14,3	0,22	7 800	0,36	A, E
WT 06-D NP	06 B-2	9,525	3/8	5,72	8,53	6,35	3,28	10,24	8,2	3,3	23,8	0,56	16 900	0,74	A, E, L
WT 08-D NP	08 B-2	12,700	1/2	7,75	11,30	8,51	4,45	13,92	11,8	3,9	31,0	1,01	32 000	1,35	A, E, L
WT 10-D NP	10 B-2	15,875	5/8	9,65	13,28	10,16	5,08	16,59	14,7	4,1	36,2	1,34	44 500	1,79	A, E, L
WT 12-D NP	12 B-2	19,050	3/4	11,68	15,62	12,07	5,72	19,46	16,1	4,6	42,2	1,79	57 800	2,22	A, E, L
WT 16-D NP	16 B-2	25,400	1	17,02	25,40	15,88	8,28	31,88	21,0	5,4	68,0	4,21	106 000	5,13	A, E, L

#### Verbindungsglieder / Connecting links



**A**

Außenglied  
(Nietglied)

Pin link



**E**

Verbindungsglied  
mit Feder

Spring  
Connecting link



**L**

Gekrüpftes Glied  
mit Splint

Offset link

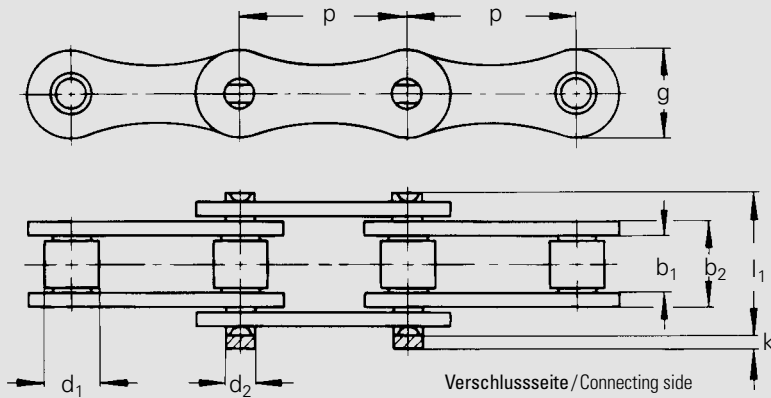

WITRA <sup>®</sup>	ISO	Teilung		Innere Breite	Innengliedbreite	Rollen-Ø	Bolzen-Ø	Laschenhöhe	Überstand	Maß über Bolzen	Gelenkfläche	Bruchkraft ISO	Gewicht	Verbindungsglieder
		Pitch		Inner width	Inner link width	Roller-Ø	Pin-Ø	Plate height	Project. over conn. link	Width over pin	Bearing area	Breaking load ISO	Weight	Connecting links
		p		b <sub>1</sub> min.	b <sub>2</sub> max.	d <sub>1</sub> max.	d <sub>2</sub> max.	g max.	k max.	l <sub>1</sub> max.	f	F <sub>B</sub> min.	q ≈	
No.	No.	mm	inch	mm	mm	mm	mm	mm	mm	mm	cm <sup>2</sup>	N	kg/m	Type
<b>Amerikanische Bauart / American Series</b>														
WT 208-A	208 A	25,40	1	7,85	11,15	7,95	3,96	12,0	3,9	17,8	0,44	14 100	0,49	A, E, S, L
WT 210-A	210 A	31,75	1 ¼	9,40	13,80	10,16	5,08	15,0	4,1	21,8	0,70	22 200	0,64	A, E, S, L
WT 212-A	212 A	38,10	1 ½	12,57	17,70	11,91	5,94	18,0	4,6	26,9	1,05	31 800	1,02	A, E, S, L
WT 216-A	216 A	50,80	2	15,75	22,50	15,88	7,92	24,1	5,4	33,5	1,78	56 700	1,71	A, S, L
WT 220-A	220 A	63,50	2 ½	18,90	27,40	19,05	9,53	30,0	4,3	40,4	2,59	86 700	2,55	A, S, L
<b>Europäische Bauart / European Series</b>														
WT 208-B	208 B	25,40	1	7,75	11,30	8,51	4,45	11,8	3,9	17,0	0,50	18 000	0,46	A, E, S, L
WT 210-B	210 B	31,75	1 ¼	9,65	13,28	10,16	5,08	14,7	4,1	19,6	0,67	22 400	0,57	A, E, S, L
WT 212-B	212 B	38,10	1 ½	11,68	15,62	12,07	5,72	16,1	4,6	22,7	0,89	29 000	0,75	A, E, S, L
WT 216-B	216 B	50,80	2	17,02	25,40	15,88	8,28	21,0	5,4	36,1	2,10	60 000	1,74	A, S, L
WT 220-B	220 B	63,50	2 ½	19,56	29,00	19,05	10,19	28,5	6,1	43,2	2,96	95 000	2,55	A, S, L

Verbindungsglieder / Connecting links



**A**

Außenglied  
(Nietglied)

Pin link



**B**

Innenglied

Inner link



**E**

Verbindungsglied  
mit Feder

Spring  
Connecting link



**S**

Verbindungsglied  
mit Splinten

Cotter pin  
Connecting link



**L**

Gekröpftes Glied  
mit Splint

Offset link

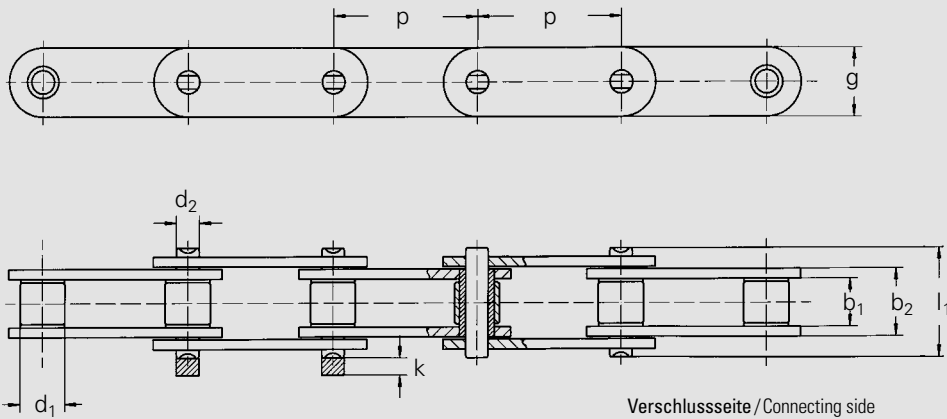

WITRA®	ISO	Teilung		Innere Breite	Innengliedbreite	Rollen-Ø	Bolzen-Ø	Laschenhöhe	Überstand	Maß über Bolzen	Gelenkfläche	Bruchkraft ISO	Gewicht	Verbindungsglieder
		Pitch		Inner width	Inner link width	Roller-Ø	Pin-Ø	Plate height	Project. over conn. link	Width over pin	Bearing area	Breaking load ISO	Weight	Connecting links
		p		b <sub>1</sub> min.	b <sub>2</sub> max.	d <sub>1</sub> max.	d <sub>2</sub> max.	g max.	k max.	l <sub>1</sub> max.	f	F <sub>B</sub> min.	q ≈	
No.	No.	mm	inch	mm	mm	mm	mm	mm	mm	mm	cm <sup>2</sup>	N	kg/m	Type
WT C 2050	C 210 A	31,75	1 ¼	9,40	13,84	10,16	5,09	15,10	4,1	21,8	0,70	21 800	0,81	A, E, S, L
WT C 2060	C 212 A	38,10	1 ½	12,57	17,75	11,91	5,96	18,08	4,6	26,9	1,05	31 100	1,12	A, E, S, L
WT C 2060-H	C 212 A-H	38,10	1 ½	12,57	19,43	11,91	5,96	18,08	4,6	29,8	1,16	31 100	1,44	A, E, S, L
WT C 2080	C 216 A	50,80	2	15,75	22,61	15,88	7,94	24,13	5,4	33,5	1,78	55 600	2,08	A, S, L
WT C 2080-H	C 216 A-H	50,80	2	15,75	24,28	15,88	7,94	24,13	5,4	36,7	1,92	55 600	2,54	A, S, L

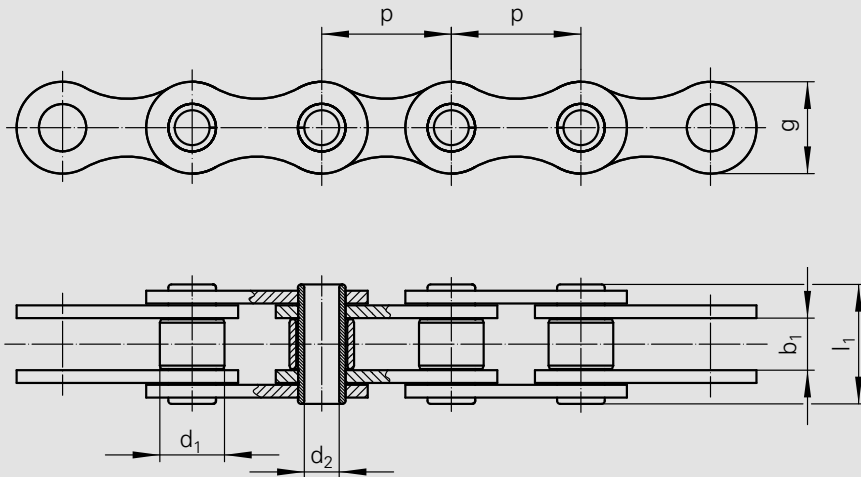

Bauart 1  
Type 1

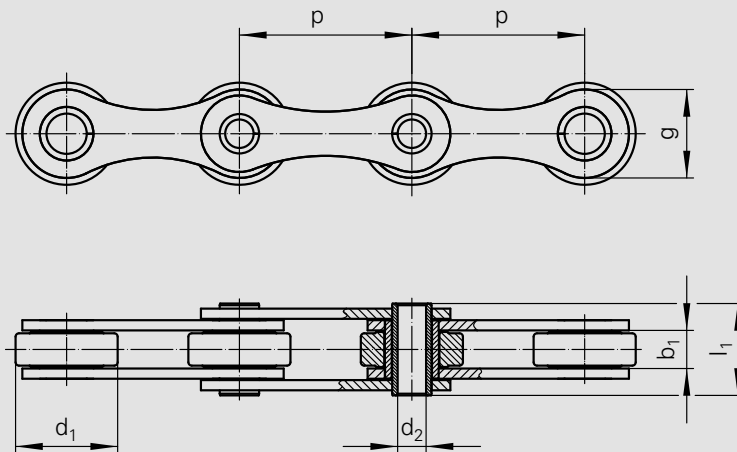

Bauart 2  
Type 2

WITRA <sup>®</sup>	Teilung		Innere Breite	Rollen-Ø	Bohrungs-Ø	Laschen-höhe	Hohlbolzen-breite	Bauart	Gelenk-fläche	Bruchkraft DIN	Gewicht
No.	mm	inch	mm	mm	mm	mm	mm	Type	cm <sup>2</sup>	N	kg/m
	Pitch		Inner width	Roller-Ø	Bore Ø	Plate height	Hollow pin width		Bearing area	Breaking load DIN	Weight
	p		b <sub>1</sub> min.	d <sub>1</sub> min.	d <sub>2</sub> max.	g max.	l <sub>1</sub> max.		f	F <sub>B</sub> min.	q ≈
WT 01463	12,7	1/2	9,50	8,51	4,00	11,8	19,0	1	0,20	14 000	0,68
WT 01650	50,8	2	10,00	30,00	8,20	26,0	27,0	2	1,94	50 000	2,15

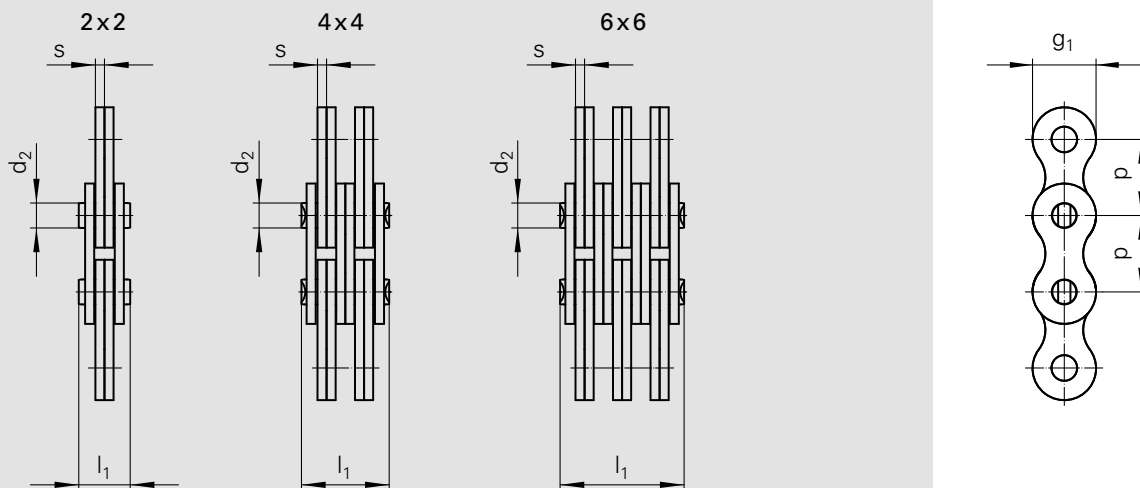

WITRA®	ISO	Nennteilung	Laschen- kombination	Laschenhöhe	Laschendicke	Bolzen- Ø	Breite über Bolzen	Bruchkraft	Gewicht
		Pitch	Lacing	Plate height	Plate thickness	Pin- Ø	Width over pin	Breaking load	Weight
		p		g <sub>1</sub> max.	s max.	d <sub>2</sub> max.	l <sub>1</sub> max.	F <sub>B</sub> min.	q ≈
No.	No.	mm		mm	mm	mm	mm	N	kg/m
WT LL0822	LL0822	12,700	2 x 2	10,6	1,60	4,45	7,9	17 800	0,41
WT LL0844	LL0844	12,700	4 x 4	10,6	1,60	4,45	14,4	31 100	0,69
WT LL0866	LL0866	12,700	6 x 6	10,6	1,60	4,45	20,5	44 500	0,97
WT LL1022	LL1022	15,875	2 x 2	13,7	1,65	5,08	9,3	22 200	0,59
WT LL1044	LL1044	15,875	4 x 4	13,7	1,65	5,08	16,1	44 500	1,13
WT LL1066	LL1066	15,875	6 x 6	13,7	1,65	5,08	22,9	66 700	1,67
WT LL1222	LL1222	19,050	2 x 2	15,0	1,85	5,72	10,7	28 900	0,64
WT LL1244	LL1244	19,050	4 x 4	15,0	1,85	5,72	18,5	57 800	1,26
WT LL1266	LL1266	19,050	6 x 6	15,0	1,85	5,72	26,3	86 700	1,88
WT LL1622	LL1622	25,400	2 x 2	21,0	3,20	8,28	17,2	58 000	1,52
WT LL1644	LL1644	25,400	4 x 4	21,0	3,20	8,28	30,2	116 000	2,98
WT LL1666	LL1666	25,400	6 x 6	21,0	3,20	8,28	43,2	174 000	4,44
WT LL2022	LL2022	31,750	2 x 2	26,4	3,70	10,19	20,1	95 000	2,33
WT LL2044	LL2044	31,750	4 x 4	26,4	3,70	10,19	35,1	190 000	4,56
WT LL2066	LL2066	31,750	6 x 6	26,4	3,70	10,19	50,1	285 000	6,79
WT LL2422	LL2422	38,100	2 x 2	33,2	5,20	14,63	28,4	170 000	4,47
WT LL2444	LL2444	38,100	4 x 4	33,2	5,20	14,63	49,4	340 000	8,67
WT LL2466	LL2466	38,100	6 x 6	33,2	5,20	14,63	70,4	510 000	12,87



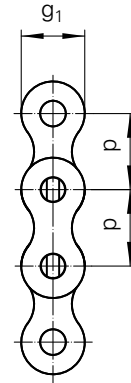
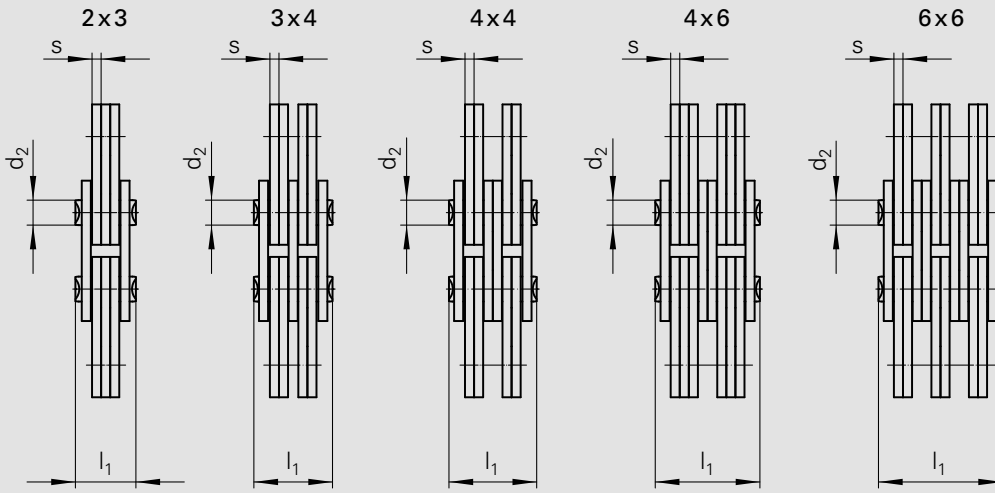

WITRA <sup>®</sup>	ISO	Nennteilung	Laschen-kombination	Laschenhöhe	Laschendicke	Bolzen-Ø	Breite über Bolzen	Bruchkraft	Gewicht
		Pitch	Lacing	Plate height	Plate thickness	Pin-Ø	Width over pin	Breaking load	Weight
		p		g <sub>1</sub> max.	s max.	d <sub>2</sub> max.	l <sub>1</sub> max.	F <sub>B</sub> min.	q ≈
No.	No.	mm		mm	mm	mm	mm	N	kg/m
WT BL0523	LH1023	15,875	2 x 3	15,0	2,42	5,94	15,37	33 400	1,16
WT BL0534	LH1034	15,875	3 x 4	15,0	2,42	5,94	20,32	48 900	1,62
WT BL0544	LH1044	15,875	4 x 4	15,0	2,42	5,94	22,78	66 700	1,84
WT BL0546	LH1046	15,875	4 x 6	15,0	2,42	5,94	27,74	66 700	2,30
WT BL0566	LH1066	15,875	6 x 6	15,0	2,42	5,94	32,69	100 100	2,74
WT BL0588	LH1088	15,875	8 x 8	15,0	2,42	5,94	42,57	133 400	3,50
WT BL0623	LH1223	19,050	2 x 3	18,0	3,25	7,92	20,73	48 900	1,80
WT BL0634	LH1234	19,050	3 x 4	18,0	3,25	7,92	27,43	75 600	2,49
WT BL0644	LH1244	19,050	4 x 4	18,0	3,25	7,92	30,78	97 900	2,83
WT BL0646	LH1246	19,050	4 x 6	18,0	3,25	7,92	37,49	97 900	3,52
WT BL0666	LH1266	19,050	6 x 6	18,0	3,25	7,92	44,20	148 800	4,21
WT BL0688	LH1288	19,050	8 x 8	18,0	3,25	7,92	57,61	195 700	5,60

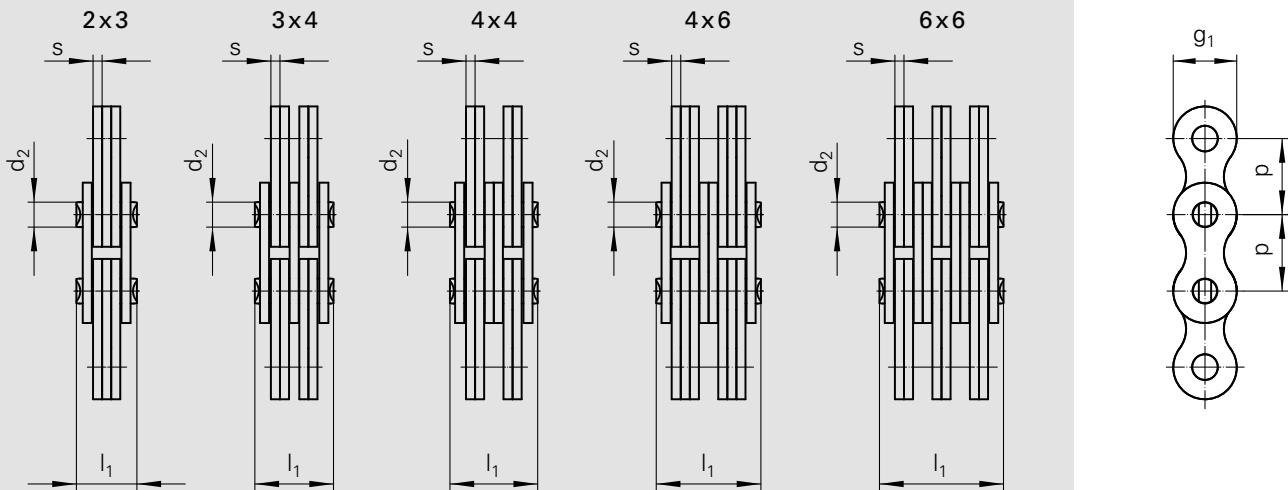

WITRA®	ISO	Nennteilung	Laschen- kombination	Laschenhöhe	Laschendicke	Bolzen- Ø	Breite über Bolzen	Bruchkraft	Gewicht
		Pitch	Lacing	Plate height	Plate thickness	Pin- Ø	Width over pin	Breaking load	Weight
		p		g <sub>1</sub> max.	s max.	d <sub>2</sub> max.	l <sub>1</sub> max.	F <sub>B</sub> min.	q ≈
No.	No.	mm		mm	mm	mm	mm	N	kg/m
WT BL0823	LH 1623	25,40	2 x 3	24,0	4,00	9,53	25,48	84 500	3,47
WT BL0834	LH 1634	25,40	3 x 4	24,0	4,00	9,53	33,76	129 000	4,82
WT BL0844	LH 1644	25,40	4 x 4	24,0	4,00	9,53	37,90	169 000	5,43
WT BL0846	LH 1646	25,40	4 x 6	24,0	4,00	9,53	46,18	169 000	6,83
WT BL0866	LH 1666	25,40	6 x 6	24,0	4,00	9,53	54,46	253 600	8,19
WT BL0888	LH 1688	25,40	8 x 8	24,0	4,00	9,53	71,02	338 100	8,60
WT BL1023	LH 2023	31,75	2 x 3	30,0	4,80	11,10	30,33	115 600	4,65
WT BL1034	LH 2034	31,75	3 x 4	30,0	4,80	11,10	40,23	182 400	6,46
WT BL1044	LH 2044	31,75	4 x 4	30,0	4,80	11,10	45,19	231 300	7,37
WT BL1046	LH 2046	31,75	4 x 6	30,0	4,80	11,10	55,09	231 300	9,18
WT BL1066	LH 2066	31,75	6 x 6	30,0	4,80	11,10	65,00	347 000	11,00
WT BL1088	LH 2088	31,75	8 x 8	30,0	4,80	11,10	84,81	462 600	13,80
WT BL1234	LH 2434	38,10	3 x 4	36,20	5,77	12,71	47,07	244 600	8,10
WT BL1244	LH 2444	38,10	4 x 4	36,20	5,77	12,71	52,88	302 500	9,30
WT BL1246	LH 2446	38,10	4 x 6	36,20	5,77	12,71	64,52	302 500	11,60
WT BL1266	LH 2466	38,10	6 x 6	36,20	5,77	12,71	76,15	453 700	13,90
WT BL1288	LH 2488	38,10	8 x 8	36,20	5,77	12,71	99,42	605 000	18,60
WT BL1634	LH 3234	50,80	3 x 4	48,26	7,52	17,46	61,72	440 400	14,00
WT BL1644	LH 3244	50,80	4 x 4	48,26	7,52	17,46	69,29	573 800	16,00
WT BL1646	LH 3246	50,80	4 x 6	48,26	7,52	17,46	84,43	573 800	20,00
WT BL1666	LH 3266	50,80	6 x 6	48,26	7,52	17,46	99,57	857 400	24,00
WT BL1688	LH 3288	50,80	8 x 8	48,26	7,52	17,46	129,84	1 156 500	32,00

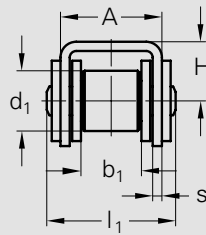
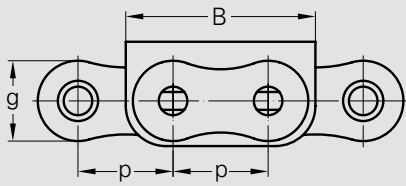

**Profil 1**  
Profile 1

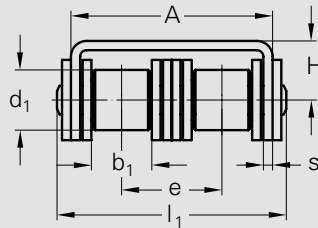
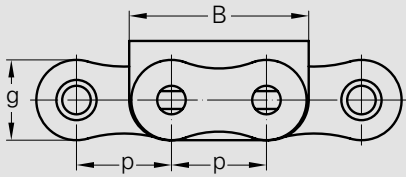

**Profil 2**  
Profile 2

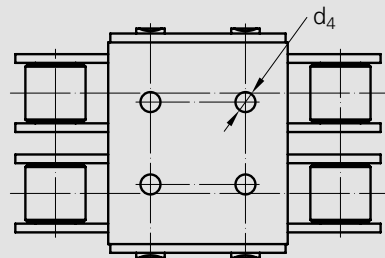
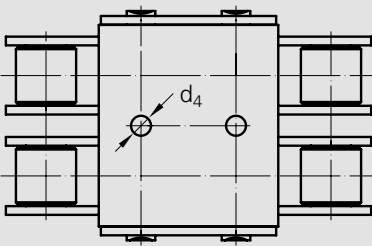

**Profil 3**  
Profile 3

WITRA <sup>®</sup>	Teilung		Innere Breite	Innengliedbreite	Rollen-Ø	La-schen-höhe	Maß über Bolzen	Quer-teilung	Mitnehmer-Maße					Profil	Gewicht	Verbindungs-glieder
	Pitch		Inner width	Inner link width	Roller-Ø	Plate height	Width over pin	Transverse pitch	Attachment dimensions					Profile	Weight	Connecting links
	p		b <sub>1</sub> min.	b <sub>2</sub> max.	d <sub>1</sub> max.	g max.	l <sub>1</sub> max.	e	A	B	H	d <sub>4</sub>	s	q ≈	Type	
No.	mm	inch	mm	mm	mm	mm	mm	mm	mm	mm	mm	mm	mm	kg/m		
08B-1 U1	12,70	½	7,75	11,30	8,51	11,80	20,00	-	14,60	24,20	8,30	4,00	1,60	1	1,13	A, E
08B-2 U1	12,70	½	7,75	11,30	8,51	11,80	34,30	13,92	28,40	24,20	8,30	4,00	1,60	3	1,96	A, E
12B-1 U1	19,05	¾	11,68	15,62	12,70	16,00	25,70	-	19,60	36,00	13,00	5,00	1,85	1	1,90	A, E
12B-2 U1	19,05	¾	11,68	15,62	12,70	16,00	45,30	19,46	39,10	36,00	13,00	5,00	1,85	3	3,03	A, E
16B-1 U1	25,40	1	17,02	25,40	15,88	21,00	39,70	-	29,05	49,00	15,40	6,00	1,60	1	3,73	A, E, S
16B-2 U1	25,40	1	17,02	25,40	15,88	21,00	71,70	31,88	60,93	49,00	16,20	6,00	1,60	2	6,15	A, E, S

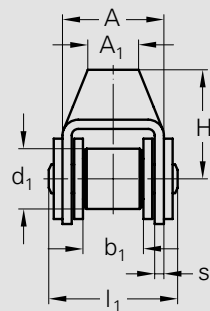
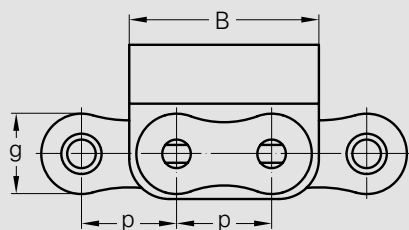

Profil 1  
Profile 1

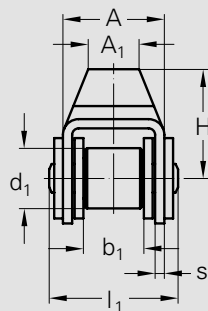
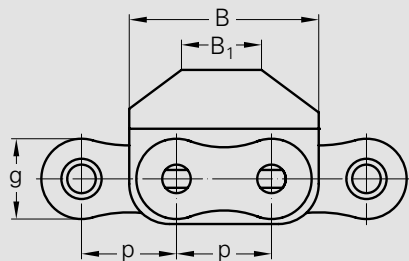
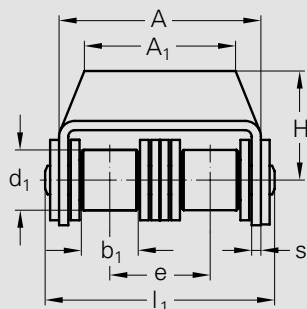
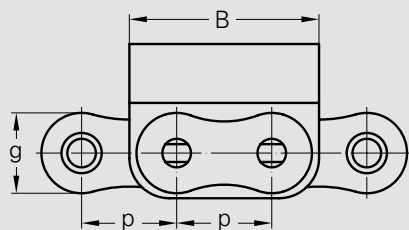

Profil 2  
Profile 2

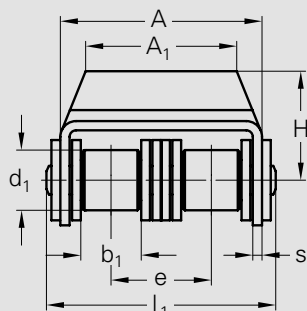
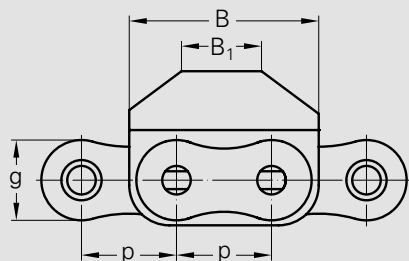

WITRA®	Teilung		Innere Breite	Innengliedbreite	Rollen-Ø	Laschenhöhe	Maß über Bolzen	Quer- teilung	Mitnehmer-Maße						Profil	Gewicht	Verbindungs- glieder			
	Pitch								Attachment dimensions									Profil	Weight	Connecting links
	p								b <sub>1</sub> min.	b <sub>2</sub> max.	d <sub>1</sub> max.	g max.	l <sub>1</sub> max.	e						
No.	mm	inch	mm	mm	mm	mm	mm	mm	mm	mm	mm	mm	mm	mm	mm	mm	mm	kg/m	Type	
08B-1 G1	12,70	1/2	7,75	11,30	8,51	11,80	20,00	-	14,60	-	24,20	-	12,30	1,50	1	1,19	A, E			
08B-2 G1	12,70	1/2	7,75	11,30	8,51	11,80	34,30	13,92	28,40	-	24,20	-	12,30	1,50	1	2,07	A, E			
08B-2 G2	12,70	1/2	7,75	11,30	8,51	11,80	34,30	13,92	28,40	25,40	24,20	9,00	12,00	1,50	2	2,00	A, E			
12B-1 G1	19,05	3/4	11,68	15,62	12,70	16,00	25,70	-	19,60	-	36,00	-	21,00	1,85	1	2,01	A, E			
12B-2 G2	19,05	3/4	11,68	15,62	12,70	16,00	45,30	-	19,60	18,60	36,00	26,00	21,00	1,85	2	2,01	A, E			
12B-2 G1	19,05	3/4	11,68	15,62	12,70	16,00	45,30	19,46	39,10	-	36,00	-	16,00	1,85	1	3,21	A, E			
16B-1 G1	25,40	1	17,02	25,40	15,88	21,00	39,70	-	29,05	29,05	49,00	25,00	21,40	1,60	2	3,83	A, E, S			
C 16B-1 G1	25,40	1	17,02	25,40	15,88	21,00	39,70	-	29,05	29,05	49,00	25,00	21,40	1,60	2	4,11	A, E, S			
16B-1 G2	25,40	1	17,02	25,40	15,88	21,00	39,70	-	29,05	29,05	49,00	41,00	21,40	1,60	2	3,83	A, E, S			

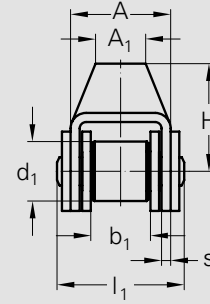
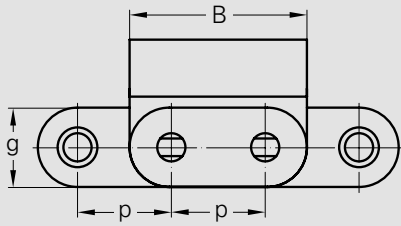

**Profil 1**  
Profile 1

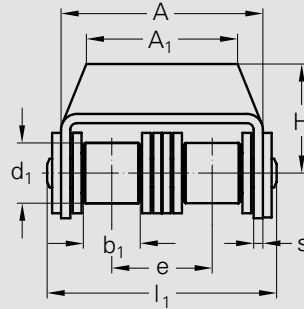
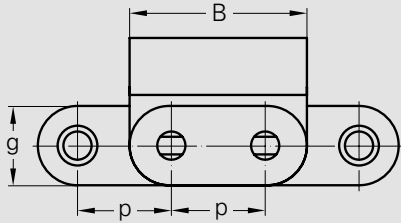

**Profil 2**  
Profile 2

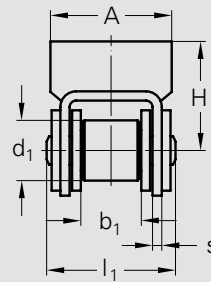
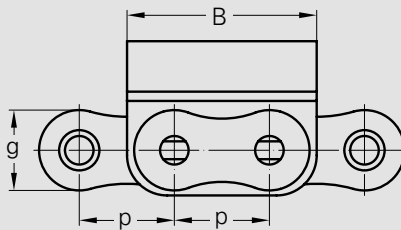

**Profil 3**  
Profile 3

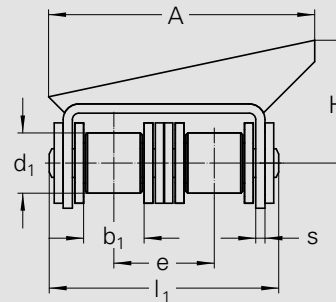
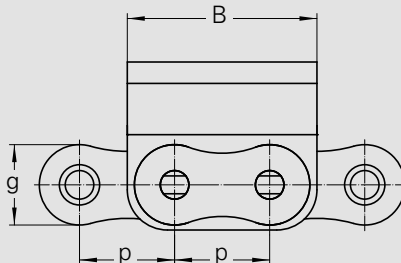

**Profil 4**  
Profile 4

WITRA <sup>®</sup>	Teilung		Innere Breite	Innengliedbreite	Rollen-Ø	La-schenhöhe	Maß über Bolzen	Quer-teilung	Mitnehmer-Maße					Profil	Gewicht	Verbindungs-glieder			
	Pitch		Inner width	Inner link width	Roller-Ø	Plate height	Width over pin		Attachment dimensions								Profile	Weight	Connecting links
	p		b <sub>1</sub> min.	b <sub>2</sub> max.	d <sub>1</sub> max.	g max.	l <sub>1</sub> max.		e	A	A <sub>1</sub>	B	H				s	q	≈
<b>C 08B-1 G1</b>	12,70	1/2	7,75	11,30	8,51	11,80	20,00	-	14,60	12,00	24,20	12,30	1,60	1	1,30	A, E			
<b>08B-1 G2</b>	12,70	1/2	7,75	11,30	8,51	11,80	20,00	-	18,00	-	24,20	12,30	1,50	3	1,21	A, E			
<b>C 08B-2 G1</b>	12,70	1/2	7,75	11,30	8,51	11,80	34,30	13,92	28,40	24,00	24,20	12,30	1,50	2	2,29	A, E			
<b>08B-2 G3</b>	12,70	1/2	7,75	11,30	8,51	11,80	34,30	13,92	37,90	-	24,20	18,30	1,50	4	2,29	A, E			
<b>C 12B-1 G1</b>	19,05	3/4	11,68	15,62	12,70	16,00	25,70	-	19,60	10,00	36,00	21,00	1,85	1	2,15	A, E			
<b>C 12B-2 G1</b>	19,05	3/4	11,68	15,62	12,70	16,00	45,30	19,46	39,10	37,00	36,00	16,00	1,85	2	3,48	A, E			

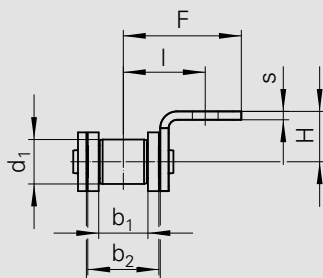
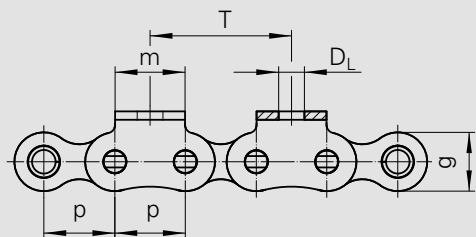

#### A

##### einseitige Winkellaschen

bent attachments,  
one side

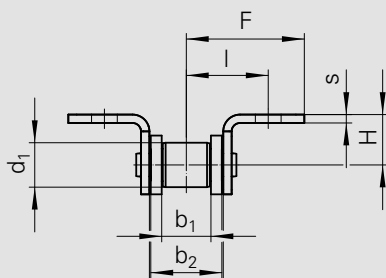
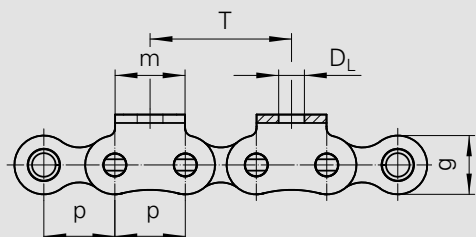

#### B

##### zweiseitige Winkellaschen

bent attachments,  
both side

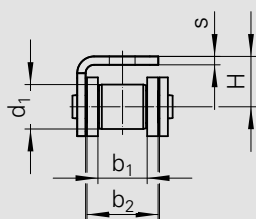
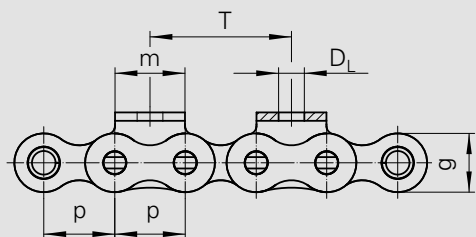

#### C

##### Winkellaschen einseitig übergreifend

bent over chain  
attachments, one side

WITRA®		Similar ISO	Nennteilung		Innere Breite	Innengliedbreite	Rollen-Ø	Laschenhöhe	Bruchkraft	Mitnehmer-Maße					
			Pitch		Inner width	Inner link width	Roller-Ø	Plate height	Breaking load DIN	Attachment dimensions					
			p		b <sub>1</sub> min.	b <sub>2</sub> max.	d <sub>1</sub> max.	g max.	F <sub>B</sub> min.	m	D <sub>L</sub>	l	F	H	s
No.	Ind.	No.	mm	inch	mm	mm	mm	mm	N	mm	mm	mm	mm	mm	mm
WT 05		05 B-1	8,000		3,00	4,77	5,00	7,1	5 000	8,0	3,20	6,6	12,0	5,0	0,80
WT 06	<sup>1</sup>	06 B-1	9,525	3/8	5,72	8,53	6,35	8,2	9 000	8,0	3,50	9,5	13,5	6,5	1,25
WT 08		08 B-1	12,700	1/2	7,75	11,30	8,51	11,8	18 000	12,5	4,50	13,1	19,0	10,0	1,50
WT 10		10 B-1	15,875	5/8	9,65	13,28	10,16	14,7	22 400	15,0	5,50	16,7	27,0	10,0	1,70
WT 12		12 B-1	19,050	3/4	11,68	15,62	12,07	16,1	29 000	18,5	6,60	18,6	29,0	11,0	1,80
WT 16		16 B-1	25,400	1	17,02	25,40	15,88	21,0	60 000	25,0	9,00	28,9	41,8	18,0	3,00
WT 20		20 B-1	31,750	1 1/4	19,56	29,00	19,05	26,4	95 000	35,0	9,00	33,4	50,0	18,0	3,75
WT 24		24 B-1	38,100	1 1/2	25,40	37,90	25,40	33,4	160 000	38,0	11,00	44,0	64,0	25,0	5,00

<sup>1</sup> nur mit geraden Laschen / <sup>1</sup> with straight side plates only

Keine Lagerware, nur auf Anfrage. / Not on stock, only on request.

# Rollenketten mit Flachlaschen und Mitnehmerbolzen

Roller chains with single hole straight attachments and extended pins

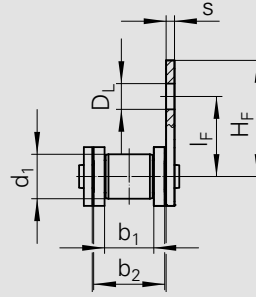
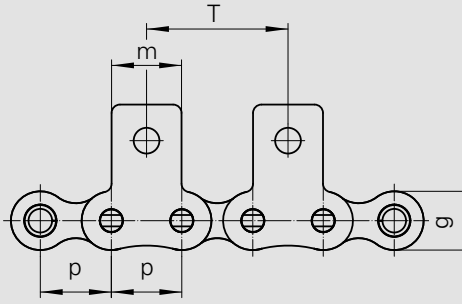

**D**

**einseitige Flachlaschen**

straight attachments,  
one side

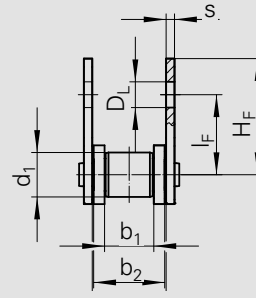
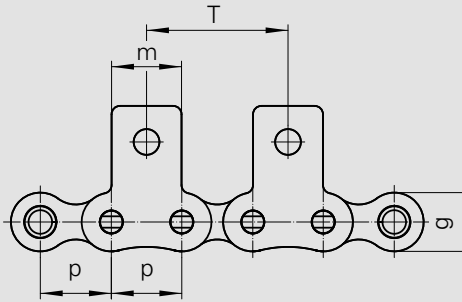

**E**

**zweiseitige Flachlaschen**

straight attachments,  
both sides

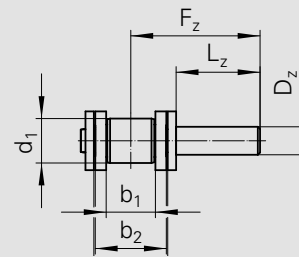
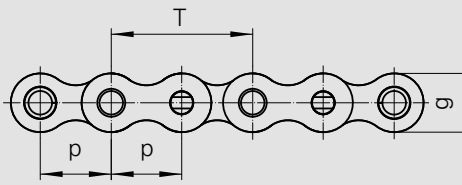

**F**

**einseitige Mitnehmerbolzen  
(auch versetzt wechselseitig  
möglich)**

extended pins, available  
on alternate sides

WITRA <sup>®</sup>		Similar ISO	Nennteilung		Innere Breite	Innengliedbreite	Rollen-Ø	Laschenhöhe	Bruchkraft	Mitnehmer-Maße							
			Pitch		Inner width	Inner link width	Roller-Ø	Plate height	Breaking load DIN	Attachment dimensions							
			p		b <sub>1</sub> min.	b <sub>2</sub> max.	d <sub>1</sub> max.	g max.	F <sub>B</sub> min.	m	D <sub>L</sub>	I <sub>F</sub>	H <sub>F</sub>	s	D <sub>Z</sub> h9	L <sub>Z</sub>	F <sub>Z</sub>
No.	Ind.	No.	mm	inch	mm	mm	mm	mm	N	mm	mm	mm	mm	mm	mm	mm	mm
WT 05		05 B-1	8,000	-	3,00	4,77	5,00	7,1	5 000	8,0	3,00	7,5	13,0	0,80	4,0	10	13,3
WT 06	<sup>1</sup>	06 B-1	9,525	3/8	5,72	8,53	6,35	8,2	9 000	8,0	3,50	9,0	13,8	1,25	5,0	15	20,7
WT 08		08 B-1	12,700	1/2	7,75	11,30	8,51	11,8	18 000	12,5	4,50	14,7	20,3	1,50	6,0	15	22,4
WT 10		10 B-1	15,875	5/8	9,65	13,28	10,16	14,7	22 400	15,0	5,50	17,2	26,7	1,70	6,5	20	28,5
WT 12		12 B-1	19,050	3/4	11,68	15,62	12,07	16,1	29 000	18,5	6,60	18,7	29,0	1,80	7,0	20	29,8
WT 16		16 B-1	25,400	1	17,02	25,40	15,88	21,0	60 000	25,0	9,00	28,6	41,5	3,00	10,0	30	45,9
WT 20		20 B-1	31,750	1 1/4	19,56	29,00	19,05	26,4	95 000	35,0	9,00	30,5	45,7	3,75	12,0	30	48,4
WT 24		24 B-1	38,100	1 1/2	25,40	37,90	25,40	33,4	160 000	38,0	11,00	41,0	60,0	5,00	16,0	35	59,1

<sup>1</sup> nur mit geraden Laschen / <sup>1</sup> with straight side plates only

Keine Lagerware, nur auf Anfrage. / Not on stock, only on request.

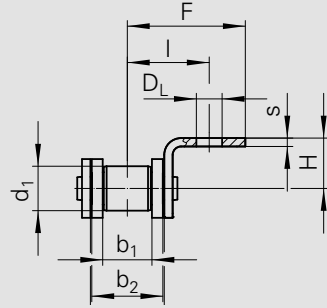
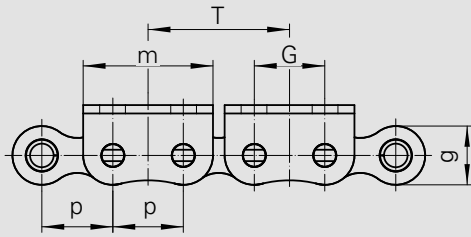

**A2**  
einseitige Winkellaschen  
bent attachments,  
one side

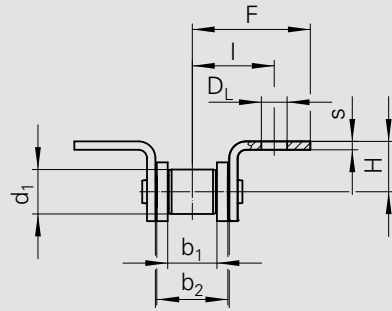
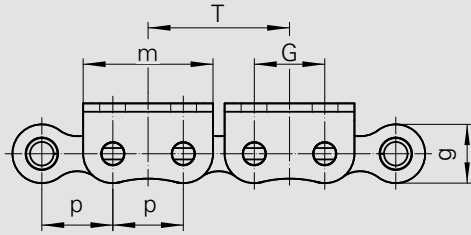

**B2**  
zweiseitige Winkellaschen  
bent attachments,  
both side

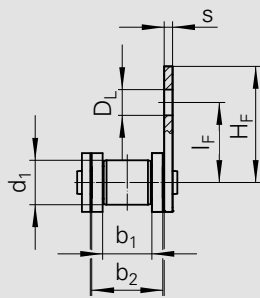
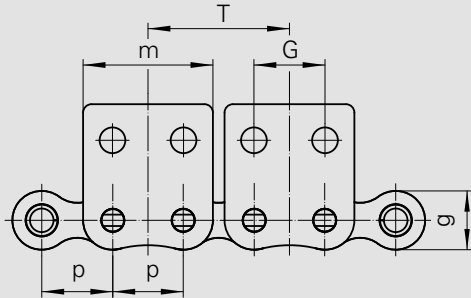

**D2**  
einseitige Flachlaschen  
straight attachments,  
one side

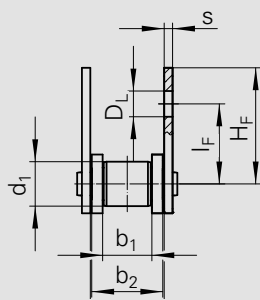
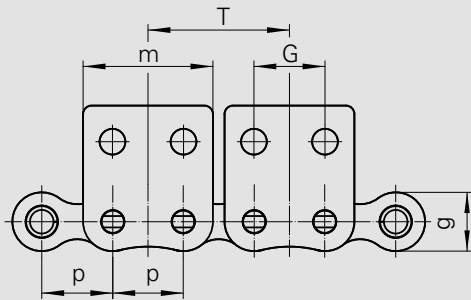

**E2**  
zweiseitige Flachlaschen  
straight attachments,  
both sides

WITRA®		Similar ISO	Nennteilung		Innere Breite	Innengliedbreite	Rollen-Ø	Laschenhöhe	Bruchkraft DIN	Mitnehmer-Maße								
			Pitch		Inner width	Inner link width	Roller-Ø	Plate height	Breaking load DIN	Attachment dimensions								
			p		b <sub>1</sub> min.	b <sub>2</sub> max.	d <sub>1</sub> max.	g max.	F <sub>B</sub> min.	m	D <sub>L</sub>	G	I	F	H	I <sub>F</sub>	H <sub>F</sub>	s
No.	Ind.	No.	mm	inch	mm	mm	mm	mm	N	mm	mm	mm	mm	mm	mm	mm	mm	mm
WT 06	1	06 B-1	9,525	3/8	5,72	8,53	6,35	8,2	9 000	18,2	3,20	9,525	9,8	13,2	5,7	9,2	12,6	1,25
WT 08		08 B-1	12,700	1/2	7,75	11,30	8,51	11,8	18 000	23,2	4,50	12,700	13,1	19,0	10,0	14,7	20,3	1,50
WT 10		10 B-1	15,875	5/8	9,65	13,28	10,16	14,7	22 400	28,5	5,50	15,900	16,7	27,0	10,0	17,2	26,7	1,70
WT 12		12 B-1	19,050	3/4	11,68	15,62	12,07	16,1	29 000	33,6	6,60	19,100	18,6	29,0	11,0	18,7	29,0	1,80
WT 16		16 B-1	25,400	1	17,02	25,40	15,88	21,0	60 000	46,5	9,00	25,400	28,9	42,0	18,0	28,6	41,5	3,00
WT 20		20 B-1	31,750	1 1/4	19,56	29,00	19,05	26,4	95 000	55,7	9,00	31,750	33,4	50,0	18,0	30,5	45,7	3,75
WT 24		24 B-1	38,100	1 1/2	25,40	37,90	25,40	33,4	160 000	77,0	11,00	38,100	44,0	63,0	25,0	41,0	60,0	5,00

<sup>1</sup> nur mit geraden Laschen / <sup>1</sup> with straight side plates only

Keine Lagerware, nur auf Anfrage. / Not on stock, only on request.



# Rollenketten „rostfrei“ mit breiten Winkel- und Flachlaschen

Roller chains „stainless steel“ with two hole bent and straight attachments

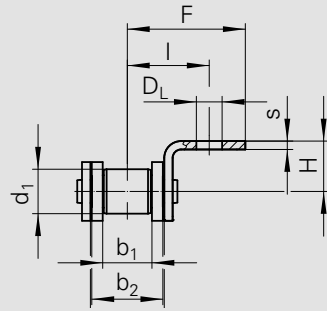
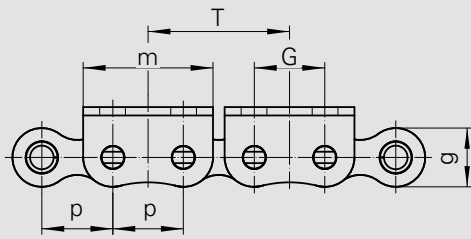

**A2**  
**einseitige Winkellaschen**  
bent attachments,  
one side

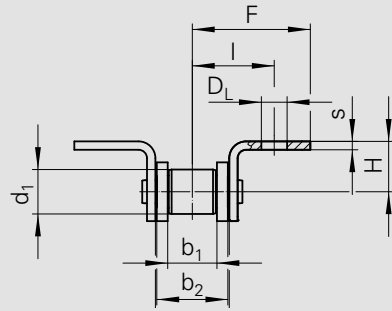
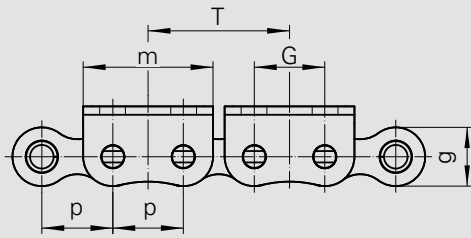

**B2**  
**zweiseitige Winkellaschen**  
bent attachments,  
both side

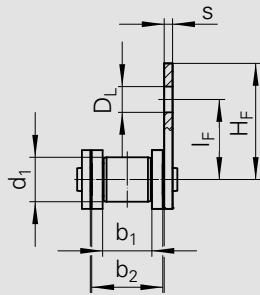
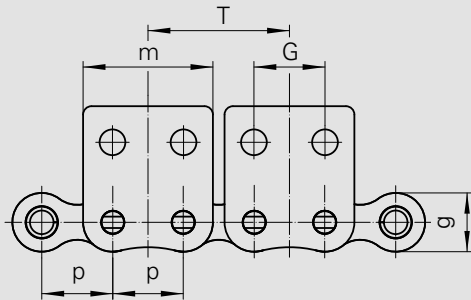

**D2**  
**einseitige Flachlaschen**  
straight attachments,  
one side

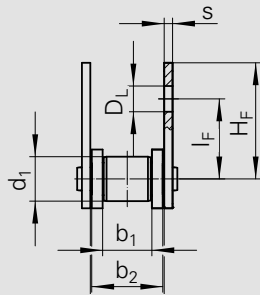
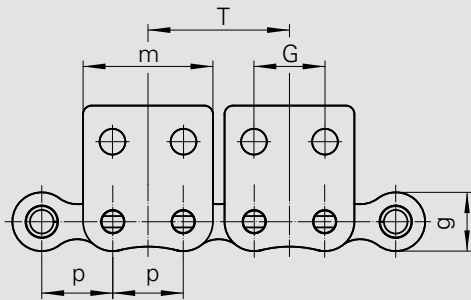

**E2**  
**zweiseitige Flachlaschen**  
straight attachments,  
both sides

WITRA <sup>®</sup>		Similar ISO	Nennteilung		Innere Breite	Innengliedbreite	Rollen-Ø	Laschenhöhe	Bruchkraft DIN	Mitnehmer-Maße								
			Pitch		Inner width	Inner link width	Roller-Ø	Plate height	Breaking load DIN	Attachment dimensions								
			p		b <sub>1</sub> min.	b <sub>2</sub> max.	d <sub>1</sub> max.	g max.	F <sub>B</sub> min.	m	D <sub>L</sub>	G	I	F	H	I <sub>F</sub>	H <sub>F</sub>	s
No.	Ind.	No.	mm	inch	mm	mm	mm	mm	N	mm	mm	mm	mm	mm	mm	mm	mm	mm
WT 06 SS	<sup>1</sup>	06B-1	9,525	3/8	5,72	8,53	6,35	8,2	7 000	18,2	3,22	9,525	9,8	13,2	5,7	9,2	12,6	1,25
WT 08 SS		08B-1	12,700	1/2	7,75	11,30	8,51	11,8	12 000	23,2	4,50	12,700	13,1	19,0	10,0	14,7	20,3	1,60
WT 10 SS		10B-1	15,875	5/8	9,65	13,28	10,16	14,7	14 500	28,5	5,50	15,900	16,7	27,0	10,0	17,2	26,7	1,70
WT 12 SS		12B-1	19,050	3/4	11,68	15,62	12,07	16,1	18 500	33,6	6,60	19,100	18,5	29,0	11,0	18,7	29,0	1,80
WT 16 SS		16B-1	25,400	1	17,02	25,40	15,88	21,0	40 000	46,5	10,00	25,400	28,9	41,8	18,0	28,6	41,5	3,00

<sup>1</sup> nur mit geraden Laschen / <sup>1</sup> with straight side plates only

Keine Lagerware, nur auf Anfrage. / Not on stock, only on request.

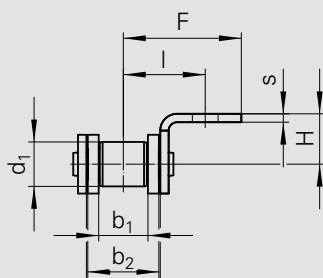
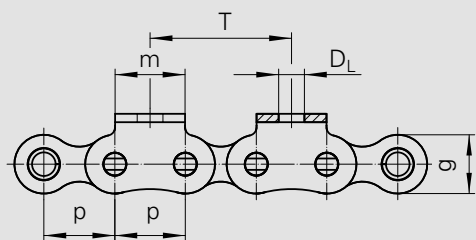

**A**  
**einseitige Winkellaschen**  
 bent attachments,  
 one side

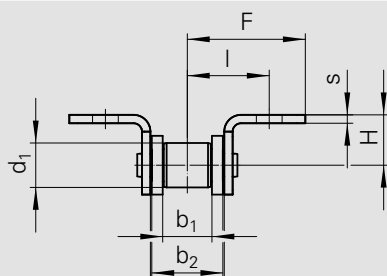
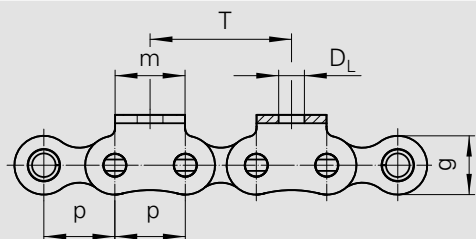

**B**  
**zweiseitige Winkellaschen**  
 bent attachments,  
 both side

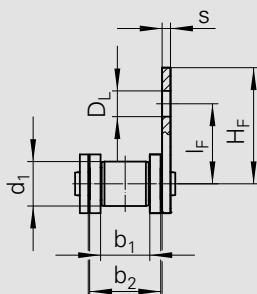
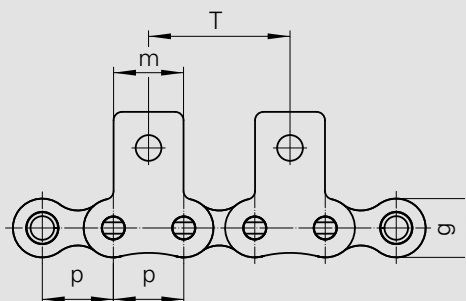

**D**  
**einseitige Flachlaschen**  
 straight attachments,  
 one side

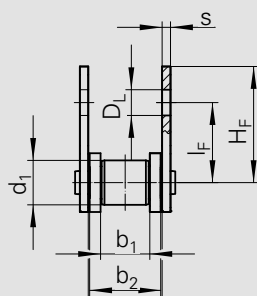
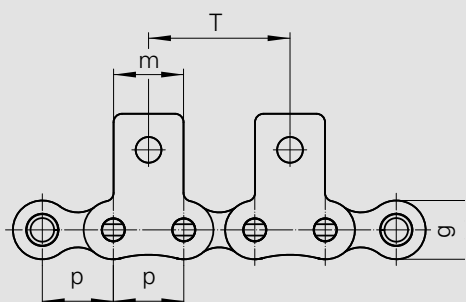

**E**  
**zweiseitige Flachlaschen**  
 straight attachments,  
 both sides

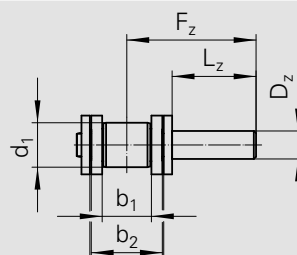
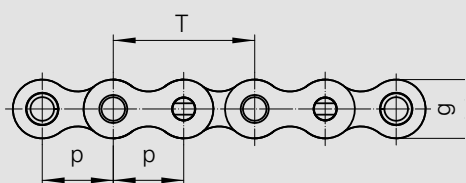

**F**  
**einseitige Mitnehmerbolzen (auch versetzt wechselseitig möglich)**  
 extended pins, available  
 on alternate sides

WITRA®		Similar ISO	Teilung		Innere Breite	Innengliedbreite	Rollen-Ø	Laschenhöhe	Mitnehmer-Maße										
No.	Ind.	No.	Pitch		Inner width	Inner link width	Roller-Ø	Plate height	Attachment dimensions										
			p		b <sub>1</sub> min.	b <sub>2</sub> max.	d <sub>1</sub> max.	g max.	m	DL	I	F	H	I <sub>F</sub>	H <sub>F</sub>	s	D <sub>Z</sub> h9	L <sub>Z</sub>	F <sub>Z</sub>
			mm	inch	mm	mm	mm	mm	mm	mm	mm	mm	mm	mm	mm	mm	mm	mm	mm
WT 05 SS		05 B-1	8,000	-	3,00	4,77	5,00	7,1	8,0	3,20	6,6	12,0	5,0	7,5	13,0	0,80	4,0	10	13,3
WT 06 SS	<sup>1</sup>	06 B-1	9,525	3/8	5,72	8,53	6,35	8,2	8,0	3,50	9,5	13,5	6,5	9,0	13,4	1,25	5,0	15	20,7
WT 08 SS		08 B-1	12,700	1/2	7,75	11,30	8,51	11,8	12,5	4,50	13,1	19,0	10,0	14,7	20,3	1,60	6,0	15	22,4
WT 10 SS		10 B-1	15,875	5/8	9,65	13,28	10,16	14,7	15,0	5,50	16,7	27,0	10,0	17,2	26,7	1,70	6,5	20	28,5
WT 12 SS		12 B-1	19,050	3/4	11,68	15,62	12,07	16,1	18,5	6,60	18,5	29,0	11,0	18,7	29,0	1,80	7,0	20	29,8
WT 16 SS		16 B-1	25,400	1	17,02	25,40	15,88	21,0	25,0	10,00	28,9	41,5	18,0	41,8	28,6	3,00	10,0	30	45,9

<sup>1</sup> nur mit geraden Laschen / <sup>1</sup> with straight side plates only

Keine Lagerware, nur auf Anfrage. / Not on stock, only on request.

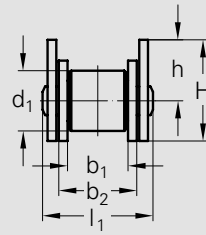
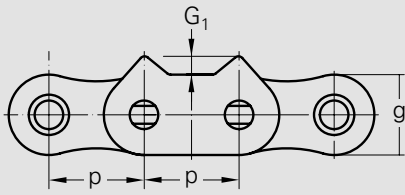

Profil 1  
Profile 1

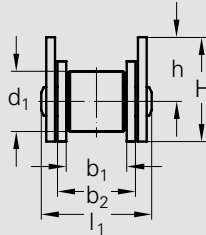
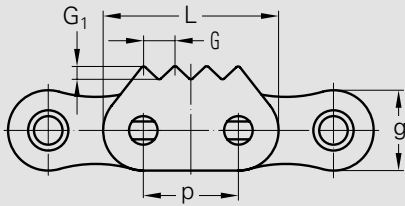

Profil 2  
Profile 2

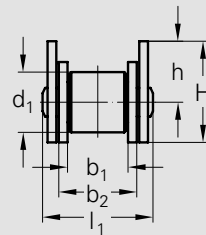
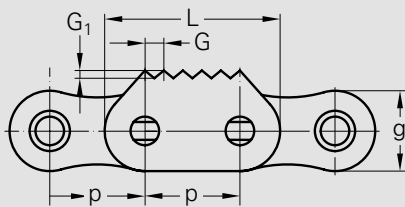

Profil 3  
Profile 3

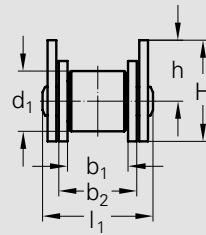
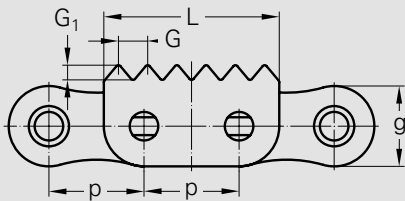

Profil 4  
Profile 4

WITRA <sup>®</sup>	Teilung		Innere Breite Inner width	Innengliedbreite Inner link width	Roller-Ø Roller-Ø	Laschenhöhe Plate height	Maß über Bolzen Width over pin	Mitnehmer-Maße					Profil Profile	Gewicht Weight	Verbindungs-glieder Connecting links
	Pitch							Attachment dimensions							
	p							G	G <sub>1</sub>	H	h	L			
No.	mm	inch	b <sub>1</sub> min.	b <sub>2</sub> max.	d <sub>1</sub> max.	g max.	l <sub>1</sub> max.	mm	mm	mm	mm	mm	kg/m	Type	
12B1-F3	19,05	¾	11,68	15,62	12,07	16,10	22,70	6,35	2,72	21,50	13,5	35,05	2*	1,48	A, E
16B1-1170	25,40	1	17,02	25,40	15,88	21,00	36,10	4,23	4,00	26,50	16,00	46,00	2	2,94	A, S
16B1-1185	25,40	1	17,02	25,40	15,88	21,00	36,10	4,00	4,00	26,50	16,00	46,00	4	3,03	A, S
16B1-1185a	25,40	1	17,02	25,40	15,88	21,00	36,10	4,00	4,00	26,50	16,00	46,00	4**	2,87	A, S
16B1-1186	25,40	1	17,02	25,40	15,88	21,00	36,10	4,00	4,00	26,50	16,00	46,00	4*	3,23	A, S
20B1-1350	31,75	1 ¼	19,56	29,00	19,05	26,40	43,20	-	6,50	33,00	19,80	-	1	4,07	A, S
20B1-1310	31,75	1 ¼	19,56	29,00	19,05	26,40	43,20	6,35	3,20	33,00	19,80	-	3	4,17	A, S
24B1-4STC	38,10	1 ½	25,40	37,90	25,40	33,40	53,40	13,00	5,60	35,00	18,30	70,40	2	7,19	A, S

\* Verzahnung an Innen- und Außenlaschen / \* Gearing on inner and outer plates  
outerplates alternating assembled

\*\* Verzahnte Außenlaschen wechselseitig montiert / \*\* Toothed

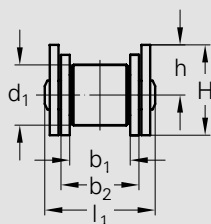
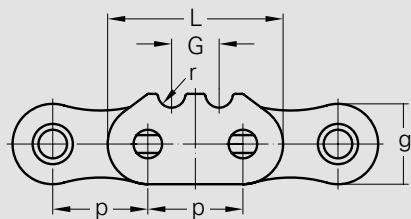

**Profil 5**  
Profile 5

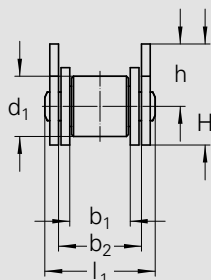
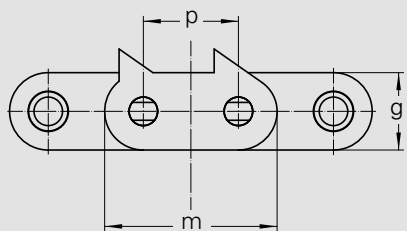

**Profil 6**  
Profile 6

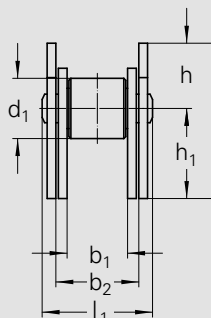
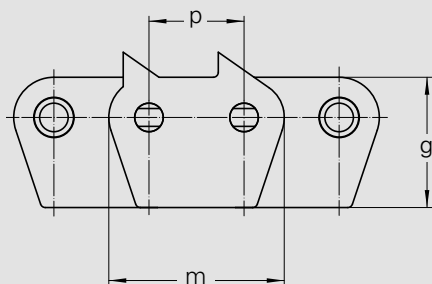

**Profil 7**  
Profile 7

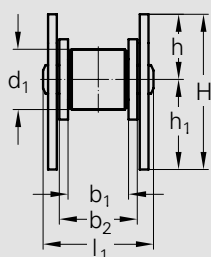
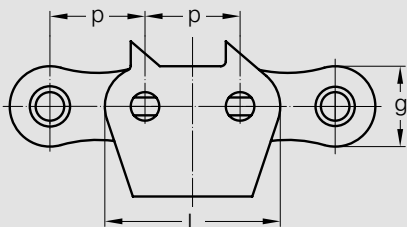

**Profil 8**  
Profile 8

WITRA®	Teilung		Innere Breite	Innengliedbreite	Rollen-Ø	Laschenhöhe	Maß über Bolzen	Mitnehmer-Maße						Profil	Gewicht	Verbindungs-glieder
	Pitch							Attachment dimensions								
	p		b <sub>1</sub> min.	b <sub>2</sub> max.	d <sub>1</sub> max.	g max.	l <sub>1</sub> max.	L	G	r	H	h	h <sub>1</sub>	q ≈	Type	
No.	mm	inch	mm	mm	mm	mm	mm	mm	mm	mm	mm	mm	mm	mm	kg/m	Type
16B1-1180	25,4	1	17,02	25,40	15,88	21,00	36,10	46,00	12,00	3,50	22,50	12,20	-	5	2,84	A, S
16B1-1161	25,4	1	17,02	25,40	15,88	21,00	36,10	46,00	-	-	27,50	16,00	-	6	3,03	A, S
32B1-1872	50,8	2	30,99	45,50	29,21	42,20	67,40	92,80	-	-	64,00	21,00	43,00	7	11,83	A, S
32B1-1874	50,8	2	30,99	45,50	29,21	42,20	67,40	92,80	-	-	73,00	30,00	43,00	8	12,27	A, S



### General information

A chain drive needs relatively little maintenance, if the correct chain was selected, if it was installed correctly and if it is lubricated according to the recommended procedure.

However, the chain should be protected against dirt and adverse environmental influences. A chain protection box helps to prevent dirt, averts accidents and absorbs noise.

In case of protected drives maintenance comprises a regular (annual) cleaning of the oil container and a renewal of the oil filling.

Open running chain drives must be cleaned every 3 to 6 months.

Shorter periods may be necessary, if the chains are very dirty. When cleaning the chain drives, wheel alignment and chain tension should be checked as well.

### Cleaning

First of all, in order to clean a chain drive properly, the external rough dirt must be removed by means of a hard or steel brush. Subsequently, the chain is rinsed in cleaning solvent, paraffin or diesel oil. Furthermore, it is important to clean the inner parts of the chain. Therefore the chain is placed into paraffin, diesel oil or another solvent for approximately 24 hours in order to soak the dirt in the joints as well as the hardened lubrication remnants.

If the chain is moved several times back and forth in the solvent bath, joints will be thoroughly cleaned.

After the chain has been properly cleaned it should not make anymore scratching noises when the links are moved; if it does, the remaining dirt in the joints will form a grinding compound with the lubricating agent, which would destroy the chain very quickly.

### Repair

Subsequently the chain should be carefully examined for defective links, which must be replaced, if necessary.



A damaged outer link is replaced with a connecting link. Outer links are riveted into endless chains.

If an inner link or a roller is broken, the two adjoining links must also be removed; they must then be replaced by an inner link with two connecting links.

With endless chains outer links are to be used. However, if a chain looks really worn, it should be replaced by a new one.

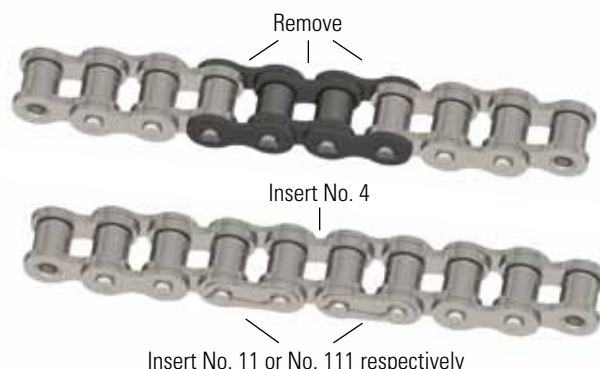

### Relubrication

Thorough relubrication is to be carried out immediately after cleaning and, if necessary, repair of the chain. It is important to ensure that quality and viscosity of the lubricant comply with the operating conditions of the chain drive, e.g. temperature and velocity. It is not recommended to add just a few drops from the oil can or simply douse the chain, since the oil will not reach the chain links, i.e. those parts which actually have to be lubricated. Even if the inner and outer plates are oiled, this will by no means guarantee a proper lubrication of the inner parts such as pins and bushings.

For perfect lubrication the chain is placed into a container with liquidised special chain lubricant heated up to 120° C. The chain is left in the lubricant bath until it has reached its temperature, before it is then taken out. Excess lubricant must be allowed to drip off since it will not aid the lubrication of the chains links if it sticks to the outer plates.

However, in practice, such perfect lubrication will rarely be possible. In this case an excellent engine lubricating oil should be used. Please ensure that the lubricant will actually reach the links, which are to be lubricated.

### Sprockets

The sprocket teeth must be thoroughly cleaned before the chain is finally put back on.



It is particularly important to remove dirt sediments, which would stretch the chain, from the bottom of the tooth gaps. Subsequently, the sprocket must be examined in order to determine, if the teeth are worn too much.

In case of excessive wear or hooked-shaped teeth, sprockets should be replaced with new ones.

It is not recommended to simply turn a worn sprocket around so that it works in reverse running direction. New sprockets are to be checked.

Please note that a new chain should never be placed around a worn sprocket, because this will definitely reduce the lifecycle of the chain.

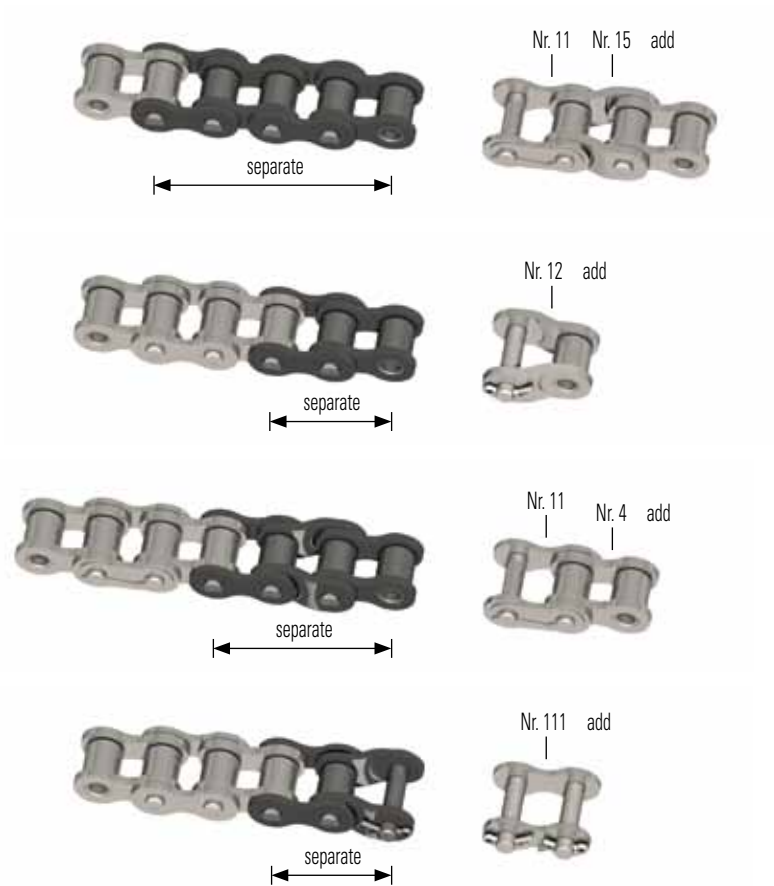

**Shortening by 1 link**

**a) Even number of links**

up to a pitch of 19,05 mm

Pitch as of 25,4 mm

**b) Odd number of links**

up to a pitch of 19,05 mm

Pitch as of 25,4 mm

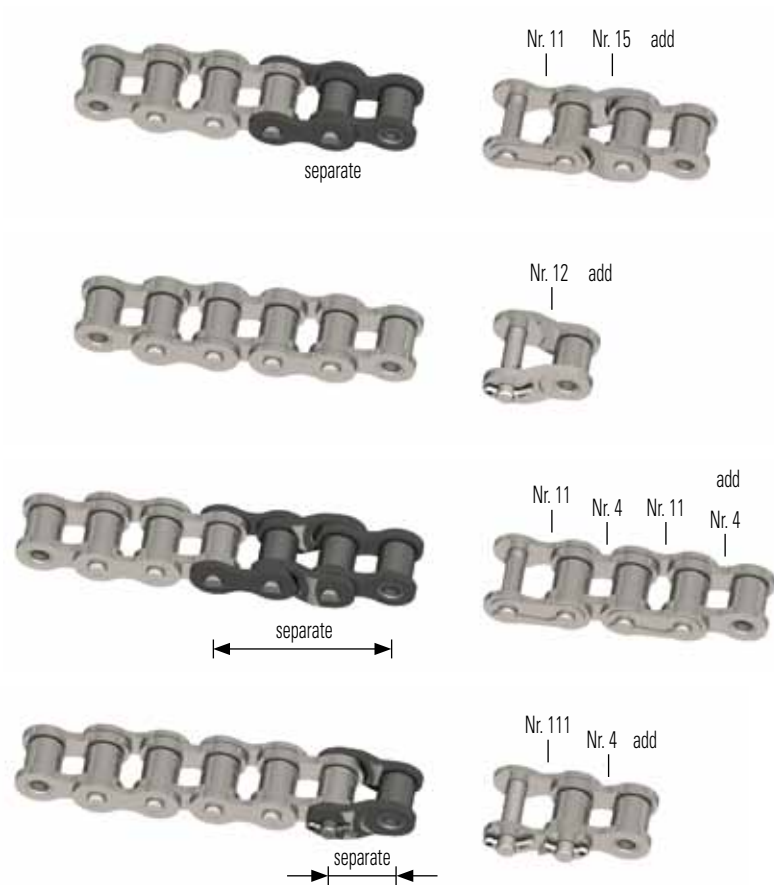

**Extending by 1 link**

**a) Even number of links**

up to a pitch of 19,05 mm

Pitch as of 25,4 mm

**b) Odd number of links**

up to a pitch of 19,05 mm

Pitch as of 25,4 mm

Please note: When cranked links are used, roller chains may only have 80 % of the tensile strength.

Folgende Kettentypen sind ab Lager lieferbar:

- Rollenketten nach ISO 606 (Europäische Bauart)
- Langgliedrige Rollenketten nach ISO 1275 (Europäische Bauart)
- Rollenketten nach ISO 606 (Amerikanische Bauart)
- Langgliedrige Rollenketten nach ISO 1275 (Amerikanische Bauart, mit geraden Laschen)
- Rollenketten nach ISO 606 (Amerikanische Bauart, verstärkt)
- Rollenketten mit geraden Laschen
- Rollenketten aus rostfreiem Stahl
- Rollenketten in vernickelter Ausführung
- Flyerketten LL-Serie nach ISO 4347
- Flyerketten BL-Serie nach ISO 4347
- Rollenketten mit Mitnehmerlaschen
- Hohlbolzenketten
- Rollenketten mit U-Bügeln
- Rollenketten mit Elastomer-Profilen
- Förderketten für die Holzindustrie & Anbauteile

The following chain types are available in stock:

- Roller chains according to ISO 606 (European type)
- Double pitch chains according to ISO 1275 (European type)
- Roller chains according to ISO 606 (American type)
- Double pitch chains according to ISO 1275 (American type, straight plates)
- Roller chains according to ISO 606 (American type, heavy series)
- Roller chains with straight side plates
- Roller chains made of stainless steel
- Nickel-plated roller chains
- Leaf chains type series LL according to ISO 4347
- Leaf chains type series BL according to ISO 4347
- Roller chains with attachment side plates
- Hollow Pin chain
- Roller chains with U-Type attachments
- Roller chains with Elastomer-Profiles
- Lumber conveyor chain & attachments

**Wippermann jr. GmbH Trading**  
Im Obrock 151-153  
32278 Kirchlengern  
Germany

**Phone** +49 5223 7633-40  
**Fax** +49 5223 7633-48

**E-mail** [witra@wippermann.com](mailto:witra@wippermann.com)  
**Internet** [witra.wippermann.com](http://witra.wippermann.com)