

ELA-flex SD[®] timing belts

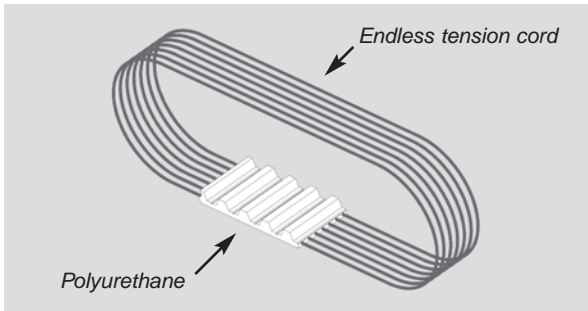

ELA-flex SD[®] Synchro Drive timing belts

ELA-flex SD[®] timing belts are manufactured with truly endless high tension strength steel tension cords and high wear, abrasion and tear resistant polyurethane.



Having no splice or welding, the belts have no weak cross sections. ELA-flex SD[®] timing belts are therefore ideal for high speed power transmission and high load conveying applications.

The unique high tech manufacturing process designed by our research and development allows the production of every belt length, tooth by tooth from a **minimum of 800 mm** to a maximum of 24.000 mm to permit the best flexibility in application.

Length tolerances

Belt length [mm]	Length tolerance (+/-) [mm]	Belt length [mm]	Length tolerance (+/-) [mm]
900	0,75	4000	2,11
1100	0,85	4250	2,24
1300	0,95	4500	2,32
1500	1,04	4750	2,40
1700	1,13	5000	2,52
1900	1,22	5300	2,64
2120	1,30	5600	2,72
2240	1,35	6000	2,92
2360	1,44	6300	3,04
2500	1,49	6700	3,19
2650	1,57	7100	3,35
2800	1,61	7500	3,51
3000	1,70	8000	3,70
3550	1,91	9000	4,09
3750	2,03	more	on request

Double sided timing belts

On demand it is possible to supply ELA-flex SD[®] as double sided belts. Please ask for the minimum quantity.

Product certification

- ELATECH[®] belts are certified according to RoHS 2011/65/UE
- On request, it is possible to deliver belts with antistatic properties.

Special cords

In order to solve any design needs, ELA-flex SD[®] belts may be produced with special cords:

- HPL** high performance
- HFE** high Flexibility
- INOX** stainless steel for high aggressive environments
- ARAMID** low weight, non magnetic

Antistatic belts

On request it is possible to deliver ELA-flex SD[®] belts with anti-static properties by using a specific electrically conductive coating or a special compound. A minimum quantity is applied.

Thickness and width tolerance

Standard ELA-flex SD[®] belts are ground on the back and are manufactured at precise width (see technical tables).

For special application needs, special thickness and width tolerances can be produced.

Belt designation

Ordering example "AT" metric pitch :

ELA-flex SD[®] metric pitch **F 075 AT20 A 11200 / Z**

ELA-flex SD[®] Belt

Width mm (3 digits)

Profile "AT" pitch 20 mm

A= steel cords
S= inox cords
K= Kevlar[®] cords
F= high flexibility cords
P= high power cords

Length 11200 mm (5 digits)

Z= fabric on teeth (PAZ)
R= fabric on back (PAR)
D= fabric on PAZ + PAR

Ordering example "H" inch pitch:

ELA-flex SD[®] Inch pitch **F 200 H A 01702 / Z**

ELA-flex SD[®] Belt

Width (x 0,254 = mm) - 3 digits

Profile "H"

A= steel cords
S= inox cords
K= Kevlar[®] cords
F= high flexibility cords
P= high power cords

Length 1702 mm (5 digits)

Z= fabric on teeth (PAZ)
R= fabric on back (PAR)
D= fabric on PAZ + PAR

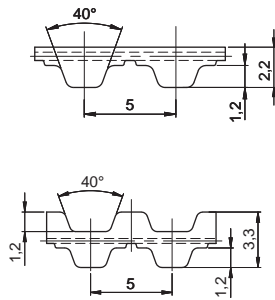
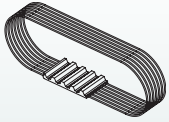

Belt characteristics

- Truly endless polyurethane timing belt with steel tension cords
- Tooth profile according to ISO 17396
- Metric pitch 5 mm
- Ideal for drives where high belt flexibility is required
- Allows the use of small diameter pulleys
- Transmissible power up to 5 kW
- Rpm up to 10.000 [1/min]
- **Dual tothing available from 1500 mm**

- Maximum width: 150 [mm]
- Width tolerance: ±0,5 [mm]
- Thickness tolerance: ±0,2 [mm]

Technical Data

Belt width [mm]	10	16	25	32	50	75	100	150
Allowable tensile load [N]	320	530	840	1090	1720	2600	3450	5170
Weight [kg/m]	0,02	0,03	0,05	0,07	0,11	0,16	0,21	0,32

Other widths are available on request.

Tooth shear strength

rpm [min ⁻¹]	M _{spez} [Ncm/cm]	P _{spez} [W/cm]	rpm [min ⁻¹]	M _{spez} [Ncm/cm]	P _{spez} [W/cm]	rpm [min ⁻¹]	M _{spez} [Ncm/cm]	P _{spez} [W/cm]
0	1,966	0,000	1200	1,252	1,573	3400	0,972	3,462
20	1,915	0,040	1300	1,231	1,676	3600	0,957	3,609
40	1,872	0,078	1400	1,211	1,776	3800	0,942	3,749
60	1,834	0,115	1440	1,204	1,815	4000	0,928	3,886
80	1,802	0,151	1500	1,194	1,875	4500	0,895	4,218
100	1,773	0,186	1600	1,176	1,971	5000	0,866	4,533
200	1,663	0,348	1700	1,160	2,065	5500	0,840	4,835
300	1,583	0,497	1800	1,145	2,158	6000	0,815	5,120
400	1,520	0,637	1900	1,131	2,250	6500	0,793	5,395
500	1,468	0,769	2000	1,116	2,338	7000	0,772	5,658
600	1,425	0,895	2200	1,091	2,513	7500	0,753	5,912
700	1,388	1,017	2400	1,068	2,684	8000	0,735	6,153
800	1,354	1,135	2600	1,046	2,847	8500	0,717	6,382
900	1,325	1,249	2800	1,026	3,007	9000	0,701	6,607
1000	1,299	1,360	3000	1,007	3,162	9500	0,686	6,824
1100	1,274	1,467	3200	0,989	3,314	10000	0,672	7,033

The total power "P" and the total torque "M" transmitted by the belt, are calculated with the following formulas:

$$P \text{ [kW]} = P_{\text{spez}} \cdot Z_e \cdot Z_k \cdot b / 1000$$

$$M \text{ [Nm]} = M_{\text{spez}} \cdot Z_e \cdot Z_k \cdot b / 100$$

$$Z_e = \frac{Z_k \cdot \arccos\left[\frac{t \cdot (z_g - z_k)}{2 \cdot \pi \cdot A}\right]}{180}$$

- P = power in kW
- M = torque in Nm
- P_{spez} = specific power
- M_{spez} = specific torque
- Z_e = number of teeth in mesh of the small pulley
- Z_{emax} = 12
- Z_k = number of teeth of the small pulley
- b = belt width in cm
- A = centre distance [mm]
- t = pitch

Flexibility

Minimum pulley number of teeth and minimum idler diameter			
Drive without reverse bending		Timing pulley Z _{min}	10
		Flat idler running on belt teeth d _{min}	30 mm
Drive with reverse bending		Timing pulley Z _{min}	15
		Flat idler running on belt back d _{min}	30 mm

Minimum available length

Execution	Max width	
	100 mm	150 mm
Standard	≥ 800 mm	≥ 1500 mm
PAZ	≥ 800 mm	≥ 1800 mm

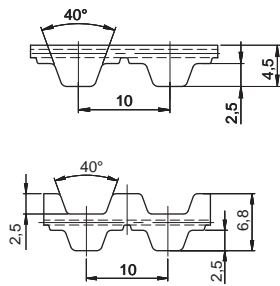
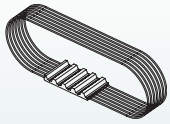

Belt characteristics

- Truly endless polyurethane timing belt with steel tension cords
- Tooth profile according to ISO 17396
- Metric pitch 10 mm
- Ideal for drives where high belt flexibility is required
- Allows the use of small diameter pulleys
- Transmissible power up to 30 kW
- Rpm up to 10.000 [1/min]
- **Dual toothing available from 1500 mm**

- Maximum width: 150 [mm]
- Width tolerance: ±0,5 [mm]
- Thickness tolerance: ±0,2 [mm]

Technical Data

Belt width [mm]	10	16	25	32	50	75	100	150
Allowable tensile load [N]	890	1520	2280	3040	4680	7080	9490	14170
Weight [kg/m]	0,05	0,07	0,12	0,15	0,23	0,35	0,46	0,69

Other widths are available on request.

Tooth shear strength

rpm [min ⁻¹]	M _{spez} [Ncm/cm]	P _{spez} [W/cm]	rpm [min ⁻¹]	M _{spez} [Ncm/cm]	P _{spez} [W/cm]	rpm [min ⁻¹]	M _{spez} [Ncm/cm]	P _{spez} [W/cm]
0	8,244	0,000	1200	4,808	6,042	3400	3,460	12,318
20	8,009	0,168	1300	4,708	6,409	3600	3,385	12,761
40	7,805	0,327	1400	4,614	6,764	3800	3,312	13,179
60	7,627	0,479	1440	4,577	6,902	4000	3,245	13,592
80	7,472	0,626	1500	4,526	7,109	4500	3,088	14,549
100	7,339	0,768	1600	4,444	7,445	5000	2,946	15,424
200	6,804	1,425	1700	4,366	7,771	5500	2,817	16,224
300	6,411	2,014	1800	4,292	8,090	6000	2,701	16,969
400	6,105	2,557	1900	4,222	8,401	6500	2,593	17,646
500	5,857	3,066	2000	4,157	8,706	7000	2,492	18,269
600	5,648	3,549	2200	4,033	9,291	7500	2,398	18,836
700	5,467	4,007	2400	3,920	9,851	8000	2,311	19,359
800	5,306	4,445	2600	3,815	10,386	8500	2,228	19,832
900	5,163	4,866	2800	3,718	10,901	9000	2,150	20,264
1000	5,034	5,271	3000	3,626	11,389	9500	2,077	20,661
1100	4,916	5,663	3200	3,541	11,866	10000	2,007	21,015

The total power "P" and the total torque "M" transmitted by the belt, are calculated with the following formulas:

$$P \text{ [kW]} = P_{\text{spez}} \cdot Z_e \cdot Z_k \cdot b / 1000$$

$$M \text{ [Nm]} = M_{\text{spez}} \cdot Z_e \cdot Z_k \cdot b / 100$$

$$Z_e = \frac{Z_k \cdot \arccos \left[\frac{t \cdot (Z_g - Z_k)}{2 \cdot \pi \cdot A} \right]}{180}$$

- P = power in kW
- M = torque in Nm
- P_{spez} = specific power
- M_{spez} = specific torque
- Z_e = number of teeth in mesh of the small pulley
- Z_{emax} = 12
- Z_k = number of teeth of the small pulley
- b = belt width in cm
- A = centre distance [mm]
- t = pitch

Flexibility

Minimum pulley number of teeth and minimum idler diameter			
Drive without reverse bending		Timing pulley Z _{min}	12
		Flat idler running on belt teeth d _{min}	60 mm
Drive with reverse bending		Timing pulley Z _{min}	20
		Flat idler running on belt back d _{min}	60 mm

Minimum available length

Execution	Max width	
	100 mm	150 mm
Standard	≥ 800 mm	≥ 1500 mm
PAZ	≥ 800 mm	≥ 1800 mm

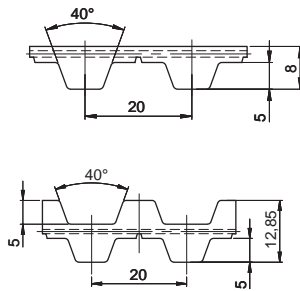
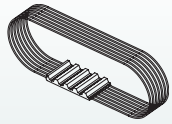

Belt characteristics

- Truly endless polyurethane timing belt with steel tension cords
- Tooth profile according to ISO 17396
- Metric pitch 20 mm
- Ideal for drives where high belt flexibility is required
- Transmissible power up to 100 kW
- Rpm up to 6.000 [1/min]
- **Dual tothing available from 1500 mm**
- **HPL cord execution available**

- Maximum width: 150 [mm]
- Width tolerance: ±1,0 [mm]
- Thickness tolerance: ±0,2 [mm]

Technical Data

Belt width [mm]	25	32	50	75	100	150
Allowable tensile load [N]	4040	5120	8090	12400	16440	24790
Weight [kg/m]	0,18	0,23	0,37	0,55	0,73	1,10

Other widths are available on request.

Tooth shear strength

rpm [min ⁻¹]	M _{spez} [Ncm/cm]	P _{spez} [W/cm]	rpm [min ⁻¹]	M _{spez} [Ncm/cm]	P _{spez} [W/cm]	rpm [min ⁻¹]	M _{spez} [Ncm/cm]	P _{spez} [W/cm]
0	33,263	0,000	1200	17,542	22,042	3400	11,510	40,978
20	32,181	0,674	1300	17,093	23,268	3600	11,173	42,117
40	31,242	1,309	1400	16,673	24,442	3800	10,851	43,178
60	30,424	1,911	1440	16,511	24,896	4000	10,546	44,170
80	29,714	2,489	1500	16,278	25,568	4500	9,842	46,377
100	29,097	3,047	1600	15,909	26,654	5000	9,209	48,213
200	26,579	5,566	1700	15,562	27,702	5500	8,639	49,753
300	24,777	7,783	1800	15,234	28,714	6000	8,114	50,976
400	23,393	9,798	1900	14,922	29,689	6500	7,630	51,931
500	22,269	11,659	2000	14,623	30,624	-	-	-
600	21,320	13,395	2200	14,069	32,411	-	-	-
700	20,502	15,028	2400	13,563	34,086	-	-	-
800	19,783	16,572	2600	13,092	35,643	-	-	-
900	19,140	18,038	2800	12,659	37,116	-	-	-
1000	18,561	19,435	3000	12,252	38,487	-	-	-
1100	18,029	20,766	3200	11,870	39,773	-	-	-

The total power "P" and the total torque "M" transmitted by the belt, are calculated with the following formulas:

$$P \text{ [kW]} = P_{spez} \cdot Z_e \cdot Z_k \cdot b / 1000$$

$$M \text{ [Nm]} = M_{spez} \cdot Z_e \cdot Z_k \cdot b / 100$$

$$Z_e = \frac{Z_k}{180} \cdot \arccos \left[\frac{t \cdot (Z_g - Z_k)}{2 \cdot \pi \cdot A} \right]$$

- P = power in kW
- M = torque in Nm
- P_{spez} = specific power
- M_{spez} = specific torque
- Z_e = number of teeth in mesh of the small pulley
- Z_{emax} = 12
- Z_k = number of teeth of the small pulley
- b = belt width in cm
- A = centre distance [mm]
- t = pitch

Flexibility

Minimum pulley number of teeth and minimum idler diameter			
Drive without reverse bending		Timing pulley Z _{min}	15
		Flat idler running on belt teeth d _{min}	120 mm
Drive with reverse bending		Timing pulley Z _{min}	25
		Flat idler running on belt back d _{min}	120 mm

Minimum available length

Execution	Max width	
	100 mm	150 mm
Standard	≥ 900 mm	≥ 1500 mm
PAZ	≥ 900 mm	≥ 1800 mm

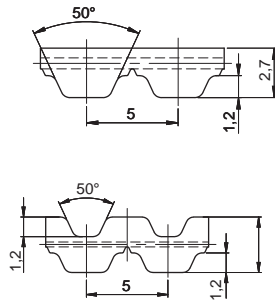
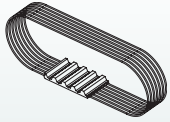

Belt characteristics

- Truly endless polyurethane timing belt with steel tension cords
- Tooth profile according to ISO 17396
- Metric pitch 5 mm
- Tooth profile and dimension are optimised to guarantee uniform load distribution and minimum deformation under load
- High resistance and low stretch steel cords to guarantee high stability and low elongation
- Reduced polygonal effect with reduced drive vibration and noise
- Transmissible power up to 15 kW
- Rpm up to 10.000 [1/min]
- **Dual tothing available from 1500 mm**

- Maximum width: 150 [mm]
- Width tolerance: ±0,5 [mm]
- Thickness tolerance: ±0,2 [mm]

Technical Data

Belt width [mm]	10	16	25	32	50	75	100	150
Allowable tensile load [N]	890	1520	2280	3040	4680	7080	9490	14230
Weight [kg/m]	0,03	0,05	0,08	0,11	0,17	0,25	0,33	0,50

Other widths are available on request.

Tooth shear strength

rpm [min ⁻¹]	M _{spez} [Ncm/cm]	P _{spez} [W/cm]	rpm [min ⁻¹]	M _{spez} [Ncm/cm]	P _{spez} [W/cm]	rpm [min ⁻¹]	M _{spez} [Ncm/cm]	P _{spez} [W/cm]
0	2,897	0,000	1200	2,027	2,547	3400	1,514	5,391
20	2,855	0,060	1300	1,990	2,709	3600	1,485	5,598
40	2,817	0,118	1400	1,955	2,866	3800	1,456	5,795
60	2,783	0,175	1440	1,942	2,929	4000	1,429	5,986
80	2,753	0,231	1500	1,923	3,020	4500	1,367	6,442
100	2,725	0,285	1600	1,892	3,170	5000	1,311	6,862
200	2,620	0,549	1700	1,863	3,316	5500	1,260	7,255
300	2,540	0,798	1800	1,836	3,460	6000	1,213	7,619
400	2,458	1,030	1900	1,809	3,599	6500	1,169	7,957
500	2,383	1,248	2000	1,784	3,736	7000	1,128	8,271
600	2,317	1,456	2200	1,736	4,000	7500	1,091	8,568
700	2,258	1,655	2400	1,693	4,256	8000	1,055	8,839
800	2,204	1,846	2600	1,653	4,500	8500	1,023	9,101
900	2,153	2,029	2800	1,615	4,734	9000	0,991	9,337
1000	2,108	2,207	3000	1,580	4,962	9500	0,961	9,555
1100	2,066	2,379	3200	1,546	5,181	10000	0,933	9,766

The total power "P" and the total torque "M" transmitted by the belt, are calculated with the following formulas:

$$P \text{ [kW]} = P_{\text{spez}} \cdot Z_e \cdot Z_k \cdot b / 1000$$

$$M \text{ [Nm]} = M_{\text{spez}} \cdot Z_e \cdot Z_k \cdot b / 100$$

$$Z_e = \frac{Z_k \cdot \arccos \left[\frac{t \cdot (Z_g - Z_k)}{2 \cdot \pi \cdot A} \right]}{180}$$

- P = power in kW
- M = torque in Nm
- P_{spez} = specific power
- M_{spez} = specific torque
- Z_e = number of teeth in mesh of the small pulley
- Z_{emax} = 12
- Z_k = number of teeth of the small pulley
- b = belt width in cm
- A = centre distance [mm]
- t = pitch

Flexibility

Minimum pulley number of teeth and minimum idler diameter			
Drive without reverse bending		Timing pulley Z _{min}	15
		Flat idler running on belt teeth d _{min}	30 mm
Drive with reverse bending		Timing pulley Z _{min}	25
		Flat idler running on belt back d _{min}	60 mm

Minimum available length

Execution	Max width	
	100 mm	150 mm
Standard	≥ 800 mm	≥ 1500 mm
PAZ	≥ 800 mm	≥ 1800 mm

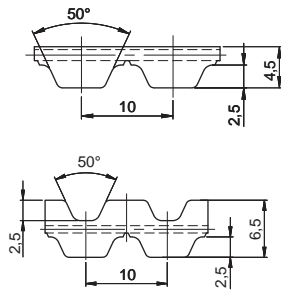
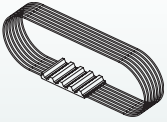

Belt characteristics

- Truly endless polyurethane timing belt with steel tension cords
- Tooth profile according to ISO 17396
- Metric pitch 10 mm
- Tooth profile and dimension are optimised to guarantee uniform load distribution and minimum deformation under load
- High resistance and low stretch steel cords to guarantee high stability and low elongation
- Reduced polygonal effect with reduced drive vibration and noise
- Transmissible power up to 70 kW
- Rpm up to 10.000 [1/min]
- **Dual tothing available from 1500 mm**
- **HPL cord execution available**

- Maximum width: 150 [mm]
- Width tolerance: ±0,5 [mm]
- Thickness tolerance: ±0,2 [mm]

Technical Data

Belt width [mm]	16	25	32	50	75	100	150
Allowable tensile load [N]	2430	4040	5120	8090	12400	16440	24790
Weight [kg/m]	0,09	0,14	0,18	0,29	0,43	0,57	0,86

Other widths are available on request.

Tooth shear strength

rpm [min ⁻¹]	M _{spez} [Ncm/cm]	P _{spez} [W/cm]	rpm [min ⁻¹]	M _{spez} [Ncm/cm]	P _{spez} [W/cm]	rpm [min ⁻¹]	M _{spez} [Ncm/cm]	P _{spez} [W/cm]
0	14,096	0,000	1200	9,018	11,331	3400	6,222	22,152
20	13,856	0,290	1300	8,815	12,000	3600	6,060	22,846
40	13,633	0,571	1400	8,626	12,645	3800	5,907	23,504
60	13,424	0,843	1440	8,553	12,897	4000	5,761	24,130
80	13,230	1,108	1500	8,447	13,268	4500	5,424	25,557
100	13,049	1,366	1600	8,279	13,871	5000	5,120	26,807
200	12,312	2,578	1700	8,119	14,454	5500	4,844	27,897
300	11,951	3,754	1800	7,968	15,018	6000	4,591	28,841
400	11,457	4,799	1900	7,824	15,566	6500	4,357	29,652
500	11,025	5,772	2000	7,686	16,097	7000	4,139	30,339
600	10,644	6,687	2200	7,429	17,113	7500	3,936	30,912
700	10,305	7,553	2400	7,191	18,072	8000	3,746	31,377
800	10,000	8,377	2600	6,971	18,978	8500	3,566	31,742
900	9,723	9,163	2800	6,766	19,836	9000	3,397	32,012
1000	9,469	9,915	3000	6,573	20,649	9500	3,236	32,193
1100	9,235	10,637	3200	6,393	21,420	10000	3,084	32,289

The total power "P" and the total torque "M" transmitted by the belt, are calculated with the following formulas:

$$P \text{ [kW]} = P_{\text{spez}} \cdot Z_e \cdot Z_k \cdot b / 1000$$

$$M \text{ [Nm]} = M_{\text{spez}} \cdot Z_e \cdot Z_k \cdot b / 100$$

$$Z_e = \frac{Z_k}{180} \cdot \arccos \left[\frac{t \cdot (Z_g - Z_k)}{2 \cdot \pi \cdot A} \right]$$

- P = power in kW
- M = torque in Nm
- P_{spez} = specific power
- M_{spez} = specific torque
- Z_e = number of teeth in mesh of the small pulley
- Z_{emax} = 12
- Z_k = number of teeth of the small pulley
- b = belt width in cm
- A = centre distance [mm]
- t = pitch

Flexibility

Minimum pulley number of teeth and minimum idler diameter			
Drive without reverse bending		Timing pulley Z _{min}	15
		Flat idler running on belt teeth d _{min}	50 mm
Drive with reverse bending		Timing pulley Z _{min}	25
		Flat idler running on belt back d _{min}	120 mm

Minimum available length

Execution	Max width	
	100 mm	150 mm
Standard	≥ 800 mm	≥ 1500 mm
PAZ	≥ 800 mm	≥ 1800 mm

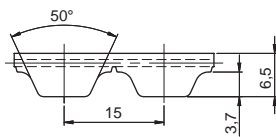
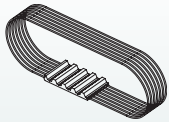

Belt characteristics

- Truly endless polyurethane timing belt with steel tension cords.
- Metric pitch 15 mm
- Tooth profile and dimension are optimised to guarantee uniform load distribution and minimum deformation under load
- High resistance and low stretch steel cords to guarantee high stability and low elongation
- Reduced polygonal effect with reduced drive vibration and noise
- Transmissible power up to 200 kW
- Rpm up to 6.000 [1/min]

- Maximum width: 150 [mm]
- Width tolerance: ±1,0 [mm]
- Thickness tolerance: ±0,2 [mm]

Technical Data

Belt width [mm]	25	32	50	75	100	150
Allowable tensile load [N]	6800	9350	15300	23800	32300	50150
Weight [kg/m]	0,22	0,28	0,44	0,66	0,88	1,33

Other widths are available on request.

Tooth shear strength

rpm [min ⁻¹]	M _{spez} [Ncm/cm]	P _{spez} [W/cm]	rpm [min ⁻¹]	M _{spez} [Ncm/cm]	P _{spez} [W/cm]	rpm [min ⁻¹]	M _{spez} [Ncm/cm]	P _{spez} [W/cm]
0	34,330	0,000	1200	19,103	24,004	3400	10,688	38,052
20	33,874	0,709	1300	18,495	25,176	3600	10,203	38,463
40	33,435	1,400	1400	17,922	26,273	3800	9,740	38,757
60	33,012	2,074	1440	17,704	26,696	4000	9,301	38,957
80	32,606	2,731	1500	17,385	27,306	4500	8,289	39,057
100	32,217	3,374	1600	16,878	28,278	5000	7,377	38,622
200	30,489	6,385	1700	16,399	29,191	5500	6,546	37,700
300	27,999	8,795	1800	15,940	30,044	6000	5,784	36,342
400	26,490	11,095	1900	15,508	30,854	-	-	-
500	25,174	13,180	2000	15,093	31,608	-	-	-
600	24,019	15,090	2200	14,317	32,981	-	-	-
700	22,992	16,853	2400	13,603	34,186	-	-	-
800	22,068	18,487	2600	12,939	35,227	-	-	-
900	21,230	20,008	2800	12,323	36,131	-	-	-
1000	20,467	21,431	3000	11,746	36,897	-	-	-
1100	19,760	22,760	3200	11,201	37,533	-	-	-

The total power "P" and the total torque "M" transmitted by the belt, are calculated with the following formulas:

$$P \text{ [kW]} = P_{spez} \cdot z_e \cdot z_k \cdot b / 1000$$

$$M \text{ [Nm]} = M_{spez} \cdot z_e \cdot z_k \cdot b / 100$$

$$z_e = \frac{z_k}{180} \cdot \arccos \left[\frac{t \cdot (z_g - z_k)}{2 \cdot \pi \cdot A} \right]$$

- P = power in kW
- M = torque in Nm
- P_{spez} = specific power
- M_{spez} = specific torque
- z_e = number of teeth in mesh of the small pulley
- z_{emax} = 12
- z_k = number of teeth of the small pulley
- b = belt width in cm
- A = centre distance [mm]
- t = pitch

Flexibility

Minimum pulley number of teeth and minimum idler diameter			
Drive without reverse bending		Timing pulley z _{min}	25
		Flat idler running on belt teeth d _{min}	120 mm
Drive with reverse bending		Timing pulley z _{min}	40
		Flat idler running on belt back d _{min}	250 mm

Minimum available length

Execution	Max width 150 mm
Standard	≥ 1500 mm
PAZ	≥ 1800 mm

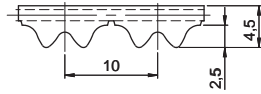
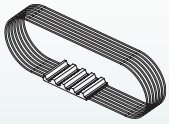

Belt characteristics

- Truly endless polyurethane timing belt with steel tension cords.
- Metric pitch 10 mm
- Tooth profile and dimension are optimised to guarantee uniform load distribution and minimum deformation under load
- High resistance and low stretch steel cords to guarantee high stability and low elongation
- Reduced polygonal effect with reduced drive vibration and noise
- Transmissible power up to 70 kW
- Rpm up to 10.000 [1/min]
- **Max. length 2400 mm**

- Maximum width: 100 [mm]
- Width tolerance: ±0,5 [mm]
- Thickness tolerance: ±0,2 [mm]

Technical Data

Belt width [mm]	16	25	32	50	75	100
Allowable tensile load [N]	2430	4040	5120	8090	12400	16440
Weight [kg/m]	0,09	0,14	0,18	0,29	0,43	0,57

Other widths are available on request.

Tooth shear strength

rpm [min ⁻¹]	M _{spez} [Ncm/cm]	P _{spez} [W/cm]	rpm [min ⁻¹]	M _{spez} [Ncm/cm]	P _{spez} [W/cm]	rpm [min ⁻¹]	M _{spez} [Ncm/cm]	P _{spez} [W/cm]
0	15,51	0,00	1200	9,92	12,46	3400	6,84	24,37
20	15,22	0,32	1300	9,70	13,20	3600	6,67	25,13
40	14,95	0,63	1400	9,49	13,91	3800	6,50	25,85
60	14,70	0,92	1440	9,41	14,19	4000	6,34	26,54
80	14,47	1,21	1500	9,29	14,59	4500	5,97	28,11
100	14,26	1,49	1600	9,11	15,26	5000	5,63	29,49
200	13,41	2,81	1700	8,93	15,90	5500	5,33	30,69
300	13,15	4,13	1800	8,76	16,52	6000	5,05	31,73
400	12,60	5,28	1900	8,61	17,12	6500	4,79	32,62
500	12,13	6,35	2000	8,45	17,71	7000	4,55	33,37
600	11,71	7,36	2200	8,17	18,82	7500	4,33	34,00
700	11,34	8,31	2400	7,91	19,88	8000	4,12	34,51
800	11,00	9,21	2600	7,67	20,88	8500	3,92	34,92
900	10,69	10,08	2800	7,44	21,82	9000	3,74	35,21
1000	10,42	10,91	3000	7,23	22,71	9500	3,56	35,41
1100	10,16	11,70	3200	7,03	23,56	10000	3,39	35,52

The total power "P" and the total torque "M" transmitted by the belt, are calculated with the following formulas:

$$P \text{ [kW]} = P_{spez} \cdot Z_e \cdot Z_k \cdot b / 1000$$

$$M \text{ [Nm]} = M_{spez} \cdot Z_e \cdot Z_k \cdot b / 100$$

$$Z_e = \frac{Z_k}{180} \cdot \arccos \left[\frac{t \cdot (Z_g - Z_k)}{2 \cdot \pi \cdot A} \right]$$

- P = power in kW
- M = torque in Nm
- P_{spez} = specific power
- M_{spez} = specific torque
- Z_e = number of teeth in mesh of the small pulley
- Z_{emax} = 12
- Z_k = number of teeth of the small pulley
- b = belt width in cm
- A = centre distance [mm]
- t = pitch

Flexibility

Minimum pulley number of teeth and minimum idler diameter			
Drive without reverse bending		Timing pulley Z _{min}	15
		Flat idler running on belt teeth d _{min}	50 mm
Drive with reverse bending		Timing pulley Z _{min}	25
		Flat idler running on belt back d _{min}	120 mm

Minimum available length

Execution	Max width 100 mm
Standard	≥ 800 mm
PAZ	≥ 800 mm

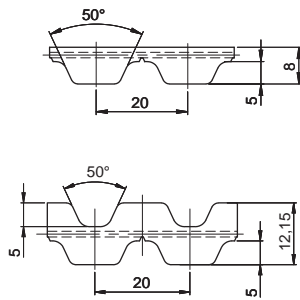
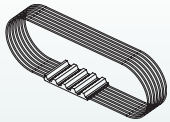

Belt characteristics

- Truly endless polyurethane timing belt with steel tension cords
- Tooth profile according to ISO 17396
- Metric pitch 20 mm
- Tooth profile and dimension are optimised to guarantee uniform load distribution and minimum deformation under load
- High resistance and low stretch steel cords to guarantee high stability and low elongation
- Reduced polygonal effect with reduced drive vibration and noise
- Transmissible power up to 200 kW
- Rpm up to 6.000 [1/min]
- **Dual tothing available from 1500 mm**
- **HPL cord execution available**

• Maximum width:	150 [mm]
• Width tolerance:	±1,0 [mm]
• Thickness tolerance:	±0,2 [mm]

Technical Data

Belt width [mm]	25	32	50	75	100	150
Allowable tensile load [N]	5280	7200	11040	16320	22080	32640
Weight [kg/m]	0,24	0,31	0,48	0,73	0,97	1,45

Other widths are available on request.

Tooth shear strength

rpm [min ⁻¹]	M _{spez} [Ncm/cm]	P _{spez} [W/cm]	rpm [min ⁻¹]	M _{spez} [Ncm/cm]	P _{spez} [W/cm]	rpm [min ⁻¹]	M _{spez} [Ncm/cm]	P _{spez} [W/cm]
0	48,192	0,000	1200	27,063	34,006	3400	15,842	56,402
20	47,288	0,990	1300	26,251	35,734	3600	15,196	57,284
40	46,438	1,945	1400	25,487	37,363	3800	14,579	58,009
60	45,639	2,867	1440	25,197	37,994	4000	13,993	58,609
80	44,885	3,760	1500	24,771	38,907	4500	12,643	59,576
100	44,175	4,626	1600	24,096	40,370	5000	11,427	59,829
200	41,199	8,628	1700	23,456	41,755	5500	10,320	59,432
300	38,923	12,227	1800	22,845	43,059	6000	9,304	58,456
400	36,911	15,460	1900	22,269	44,305	-	-	-
500	35,157	18,407	2000	21,715	45,477	-	-	-
600	33,617	21,120	2200	20,681	47,641	-	-	-
700	32,248	23,637	2400	19,729	49,580	-	-	-
800	31,016	25,982	2600	18,844	51,303	-	-	-
900	29,899	28,177	2800	18,023	52,841	-	-	-
1000	28,880	30,241	3000	17,252	54,196	-	-	-
1100	27,938	32,180	3200	16,527	55,377	-	-	-

The total power "P" and the total torque "M" transmitted by the belt, are calculated with the following formulas:

$$P \text{ [kW]} = P_{spez} \cdot Z_e \cdot Z_k \cdot b / 1000$$

$$M \text{ [Nm]} = M_{spez} \cdot Z_e \cdot Z_k \cdot b / 100$$

$$Z_e = \frac{Z_k \cdot \arccos\left[\frac{t \cdot (Z_g - Z_k)}{2 \cdot \pi \cdot A}\right]}{180}$$

- P = power in kW
- M = torque in Nm
- P_{spez} = specific power
- M_{spez} = specific torque
- Z_e = number of teeth in mesh of the small pulley
- Z_{emax} = 12
- Z_k = number of teeth of the small pulley
- b = belt width in cm
- A = centre distance [mm]
- t = pitch

Flexibility

Minimum pulley number of teeth and minimum idler diameter			
Drive without reverse bending		Timing pulley Z _{min}	18
		Flat idler running on belt teeth d _{min}	120 mm
Drive with reverse bending		Timing pulley Z _{min}	25
		Flat idler running on belt back d _{min}	180 mm

Minimum available length

Execution	Max width	
	100 mm	150 mm
Standard	≥ 900 mm	≥ 1500 mm
PAZ	≥ 900 mm	≥ 1800 mm

ELA-flex SD®

XL

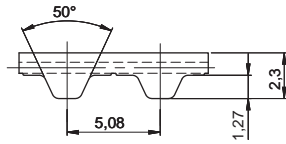
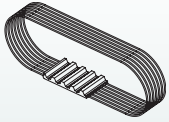

Belt characteristics

- Truly endless polyurethane timing belt with steel tension cords
- Tooth profile according to UNI/ISO 5296
- Imperial pitch 1/5" = 5,08 mm
- Allow to use small diameter pulley
- Mainly used in applications where inch pitch is an advantage
- Transmissible power up to 5 kW
- Rpm up to 10.000 [1/min]

- Maximum width: 101,6 [mm]
- Width tolerance: ±0,5 [mm]
- Thickness tolerance: ±0,2 [mm]

Technical Data

Belt width [inch] / [mm]	0,25 / 6,35	0,37 / 9,53	0,50 / 12,7	0,75 / 19,1	1,00 / 25,4	1,50 / 38,1	2,00 / 50,8	4,00 / 101,6
Allowable tensile load [N]	192	288	384	608	800	1184	1568	3168
Weight [kg/m]	0,016	0,024	0,033	0,049	0,065	0,098	0,130	0,260

Other widths are available on request.

Tooth shear strength

rpm [min ⁻¹]	M _{spez} [Ncm/cm]	P _{spez} [W/cm]	rpm [min ⁻¹]	M _{spez} [Ncm/cm]	P _{spez} [W/cm]	rpm [min ⁻¹]	M _{spez} [Ncm/cm]	P _{spez} [W/cm]
0	2,029	0,000	1200	1,294	1,626	3400	1,006	3,581
20	1,978	0,041	1300	1,273	1,732	3600	0,990	3,730
40	1,932	0,081	1400	1,252	1,836	3800	0,974	3,877
60	1,894	0,119	1440	1,245	1,877	4000	0,960	4,020
80	1,860	0,156	1500	1,234	1,938	4500	0,926	4,362
100	1,830	0,192	1600	1,216	2,037	5000	0,896	4,690
200	1,717	0,360	1700	1,200	2,136	5500	0,868	5,001
300	1,635	0,514	1800	1,184	2,231	6000	0,843	5,298
400	1,570	0,658	1900	1,169	2,326	6500	0,820	5,580
500	1,518	0,795	2000	1,155	2,418	7000	0,798	5,849
600	1,473	0,926	2200	1,129	2,600	7500	0,779	6,115
700	1,434	1,051	2400	1,104	2,776	8000	0,759	6,360
800	1,400	1,173	2600	1,082	2,945	8500	0,741	6,599
900	1,370	1,291	2800	1,061	3,110	9000	0,725	6,835
1000	1,342	1,405	3000	1,041	3,271	9500	0,709	7,053
1100	1,317	1,517	3200	1,023	3,427	10000	0,695	7,272

The total power "P" and the total torque "M" transmitted by the belt, are calculated with the following formulas:

$$P \text{ [kW]} = P_{\text{spez}} \cdot Z_e \cdot Z_k \cdot b / 1000$$

$$M \text{ [Nm]} = M_{\text{spez}} \cdot Z_e \cdot Z_k \cdot b / 100$$

$$Z_e = \frac{Z_k}{180} \cdot \arccos \left[\frac{t \cdot (Z_g - Z_k)}{2 \cdot \pi \cdot A} \right]$$

- P = power in kW
- M = torque in Nm
- P_{spez} = specific power
- M_{spez} = specific torque
- Z_e = number of teeth in mesh of the small pulley
- Z_{emax} = 12
- Z_k = number of teeth of the small pulley
- b = belt width in cm
- A = centre distance [mm]
- t = pitch

Flexibility

Minimum pulley number of teeth and minimum idler diameter			
Drive without reverse bending		Timing pulley Z _{min}	10
		Flat idler running on belt teeth d _{min}	30 mm
Drive with reverse bending		Timing pulley Z _{min}	15
		Flat idler running on belt back d _{min}	30 mm

Minimum available length

Execution	Max width 4"
Standard	≥ 800 mm
PAZ	≥ 800 mm

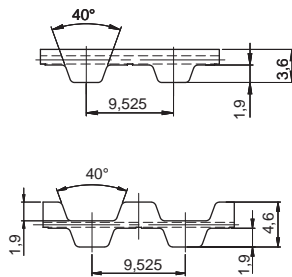
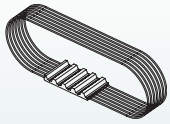
Belt characteristics

- Truly endless polyurethane timing belt with steel tension cords
- Tooth profile according to UNI/ISO 5296
- Imperial pitch 3/8" = 9,525 mm
- Mainly used in applications where inch pitch is an advantage
- Transmissible power up to 20 kW
- Rpm up to 10.000 [1/min]
- **Dual tothing available from 1500 mm**

- Maximum width: 101,6 [mm]
- Width tolerance: ±0,5 [mm]
- Thickness tolerance: ±0,2 [mm]

Technical Data

Belt width [inch] / [mm]	0,50 / 12,7	0,75 / 19,1	1,00 / 25,4	1,50 / 38,1	2,00 / 50,8	3,00 / 76,2	4,00 / 101,6
Allowable tensile load [N]	1035	1610	2185	3220	4370	6440	8625
Weight [kg/m]	0,05	0,08	0,10	0,15	0,20	0,30	0,40

Other widths are available on request.

Tooth shear strength

rpm [min ⁻¹]	M _{spez} [Ncm/cm]	P _{spez} [W/cm]	rpm [min ⁻¹]	M _{spez} [Ncm/cm]	P _{spez} [W/cm]	rpm [min ⁻¹]	M _{spez} [Ncm/cm]	P _{spez} [W/cm]
0	5,852	0,000	1200	3,393	4,263	3400	2,441	8,689
20	5,673	0,119	1300	3,321	4,521	3600	2,388	9,000
40	5,518	0,231	1400	3,256	4,774	3800	2,336	9,295
60	5,383	0,338	1440	3,230	4,871	4000	2,288	9,581
80	5,266	0,441	1500	3,194	5,017	4500	2,177	10,258
100	5,165	0,541	1600	3,137	5,255	5000	2,077	10,874
200	4,789	1,003	1700	3,082	5,486	5500	1,986	11,437
300	4,516	1,419	1800	3,029	5,709	6000	1,903	11,953
400	4,304	1,803	1900	2,980	5,930	6500	1,827	12,433
500	4,131	2,163	2000	2,933	6,143	7000	1,755	12,867
600	3,984	2,503	2200	2,845	6,555	7500	1,689	13,263
700	3,857	2,827	2400	2,765	6,949	8000	1,627	13,626
800	3,744	3,137	2600	2,692	7,330	8500	1,569	13,965
900	3,644	3,434	2800	2,623	7,689	9000	1,513	14,258
1000	3,553	3,721	3000	2,559	8,039	9500	1,461	14,537
1100	3,470	3,997	3200	2,498	8,371	10000	1,411	14,779

The total power "P" and the total torque "M" transmitted by the belt, are calculated with the following formulas:

$$P \text{ [kW]} = P_{\text{spez}} \cdot Z_e \cdot Z_k \cdot b / 1000$$

$$M \text{ [Nm]} = M_{\text{spez}} \cdot Z_e \cdot Z_k \cdot b / 100$$

$$Z_e = \frac{Z_k}{180} \cdot \arccos \left[\frac{t \cdot (Z_g - Z_k)}{2 \cdot \pi \cdot A} \right]$$

P = power in kW

M = torque in Nm

P_{spez} = specific power

M_{spez} = specific torque

Z_e = number of teeth in mesh of the small pulley

Z_{emax} = 12

Z_k = number of teeth of the small pulley

b = belt width in cm

A = centre distance [mm]

t = pitch

Flexibility

Minimum pulley number of teeth and minimum idler diameter			
Drive without reverse bending		Timing pulley Z _{min}	15
		Flat idler running on belt teeth d _{min}	60 mm
Drive with reverse bending		Timing pulley Z _{min}	20
		Flat idler running on belt back d _{min}	60 mm

Minimum available length

Execution	Max width
	4"
Standard	≥ 800 mm
PAZ	≥ 800 mm

ELA-flex SD®

H

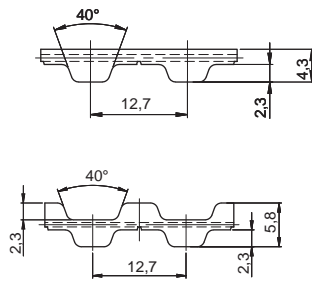
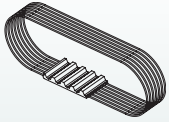

Belt characteristics

- Truly endless polyurethane timing belt with steel tension cords
- Tooth profile according to UNI/ISO 5296
- Imperial pitch 1/2" = 12,7 mm
- Allow to use small diameter pulley
- Mainly used in applications where inch pitch is an advantage
- Transmissible power up to 30 kW
- Rpm up to 10.000 [1/min]
- **Dual toothing available from 1500 mm**

- Maximum width: 101,6 [mm]
- Width tolerance: ±0,5 [mm]
- Thickness tolerance: ±0,2 [mm]

Technical Data

Belt width [inch] / [mm]	0,50 / 12,7	0,75 / 19,1	1,00 / 25,4	1,50 / 38,1	2,00 / 50,8	3,00 / 76,2	4,00 / 101,6
Allowable tensile load [N]	1035	1610	2185	3220	4370	6440	8625
Weight [kg/m]	0,056	0,084	0,113	0,169	0,225	0,338	0,450

Other widths are available on request.

Tooth shear strength

rpm [min ⁻¹]	M _{spez} [Ncm/cm]	P _{spez} [W/cm]	rpm [min ⁻¹]	M _{spez} [Ncm/cm]	P _{spez} [W/cm]	rpm [min ⁻¹]	M _{spez} [Ncm/cm]	P _{spez} [W/cm]
0	9,156	0,000	1200	5,318	6,682	3400	3,826	13,622
20	8,883	0,186	1300	5,207	7,088	3600	3,741	14,104
40	8,647	0,362	1400	5,104	7,482	3800	3,663	14,573
60	8,443	0,530	1440	5,063	7,635	4000	3,588	15,027
80	8,263	0,692	1500	5,007	7,864	4500	3,412	16,077
100	8,107	0,849	1600	4,916	8,236	5000	3,256	17,049
200	7,523	1,576	1700	4,829	8,596	5500	3,115	17,939
300	7,089	2,227	1800	4,748	8,949	6000	2,983	18,744
400	6,753	2,829	1900	4,671	9,293	6500	2,864	19,494
500	6,478	3,392	2000	4,596	9,626	7000	2,753	20,179
600	6,246	3,924	2200	4,461	10,277	7500	2,650	20,811
700	6,046	4,431	2400	4,334	10,891	8000	2,553	21,385
800	5,870	4,917	2600	4,218	11,485	8500	2,462	21,912
900	5,712	5,383	2800	4,111	12,054	9000	2,375	22,382
1000	5,569	5,831	3000	4,010	12,597	9500	2,294	22,821
1100	5,437	6,263	3200	3,915	13,119	10000	2,215	23,197

The total power "P" and the total torque "M" transmitted by the belt, are calculated with the following formulas:

$$P \text{ [kW]} = P_{\text{spez}} \cdot Z_e \cdot Z_k \cdot b / 1000$$

$$M \text{ [Nm]} = M_{\text{spez}} \cdot Z_e \cdot Z_k \cdot b / 100$$

$$Z_e = \frac{Z_k}{180} \cdot \arccos \left[\frac{t \cdot (Z_g - Z_k)}{2 \cdot \pi \cdot A} \right]$$

P = power in kW

M = torque in Nm

P_{spez} = specific power

M_{spez} = specific torque

Z_e = number of teeth in mesh of the small pulley

Z_{emax} = 12

Z_k = number of teeth of the small pulley

b = belt width in cm

A = centre distance [mm]

t = pitch

Flexibility

Minimum pulley number of teeth and minimum idler diameter			
Drive without reverse bending		Timing pulley Z _{min}	14
		Flat idler running on belt teeth d _{min}	60 mm
Drive with reverse bending		Timing pulley Z _{min}	20
		Flat idler running on belt back d _{min}	80 mm

Minimum available length

Execution	Max width 4"
Standard	≥ 800 mm
PAZ	≥ 800 mm

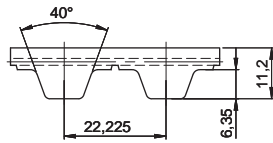
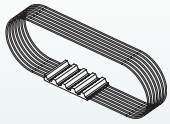

Belt characteristics

- Truly endless polyurethane timing belt with steel tension cords
- Tooth profile according to UNI/ISO 5296
- Imperial pitch 7/8" = 22,225 mm
- Mainly used in applications where inch pitch is an advantage
- Transmissible power up to 100 kW
- Rpm up to 4.500 [1/min]

- Maximum width: 152,4 [mm]
- Width tolerance: ±1,0 [mm]
- Thickness tolerance: ±0,2 [mm]

Technical Data

Belt width [inch] / [mm]	1,00 / 25,4	2,00 / 50,8	3,00 / 76,2	4,00 / 101,6	6,00 / 152,4
Allowable tensile load [N]	3675	7350	11270	14945	22295
Weight [kg/m]	0,27	0,53	0,80	1,06	1,59

Other widths are available on request.

Tooth shear strength

rpm [min ⁻¹]	M _{spez} [Ncm/cm]	P _{spez} [W/cm]	rpm [min ⁻¹]	M _{spez} [Ncm/cm]	P _{spez} [W/cm]	rpm [min ⁻¹]	M _{spez} [Ncm/cm]	P _{spez} [W/cm]
0	33,957	0,000	1200	17,802	22,369	3400	12,904	43,237
20	32,889	0,689	1300	17,405	23,692	3600	12,599	44,855
40	31,932	1,337	1400	17,037	24,975	3800	12,312	46,411
60	31,074	1,952	1440	16,897	25,477	4000	12,040	47,907
80	30,306	2,539	1500	16,693	26,220	4500	11,782	49,347
100	29,618	3,101	1600	16,372	27,430	-	-	-
200	26,460	5,541	1700	16,070	28,606	-	-	-
300	24,554	7,713	1800	15,785	29,752	-	-	-
400	23,178	9,708	1900	15,515	30,867	-	-	-
500	22,100	11,571	2000	15,259	31,955	-	-	-
600	21,213	13,327	2200	14,782	34,053	-	-	-
700	20,459	14,996	2400	14,347	36,054	-	-	-
800	19,804	16,590	2600	13,946	37,967	-	-	-
900	19,224	18,117	2800	13,574	39,798	-	-	-
1000	18,704	19,586	3000	13,433	40,509	-	-	-
1100	18,233	21,001	3200	13,228	41,553	-	-	-

The total power "P" and the total torque "M" transmitted by the belt, are calculated with the following formulas:

$$P \text{ [kW]} = P_{spez} \cdot Z_e \cdot Z_k \cdot b / 1000$$

$$M \text{ [Nm]} = M_{spez} \cdot Z_e \cdot Z_k \cdot b / 100$$

$$Z_e = \frac{Z_k \cdot \arccos \left[\frac{t \cdot (z_g - z_k)}{2 \cdot \pi \cdot A} \right]}{180}$$

- P = power in kW
- M = torque in Nm
- P_{spez} = specific power
- M_{spez} = specific torque
- Z_e = number of teeth in mesh of the small pulley
- Z_{emax} = 12
- Z_k = number of teeth of the small pulley
- b = belt width in cm
- A = centre distance [mm]
- t = pitch

Flexibility

Minimum pulley number of teeth and minimum idler diameter			
Drive without reverse bending		Timing pulley Z _{min}	18
		Flat idler running on belt teeth d _{min}	150 mm
Drive with reverse bending		Timing pulley Z _{min}	20
		Flat idler running on belt back d _{min}	180 mm

Minimum available length

Execution	Max width
	6"
Standard	≥ 1500 mm
PAZ	≥ 1800 mm

ELA-flex SD® HTD 5M

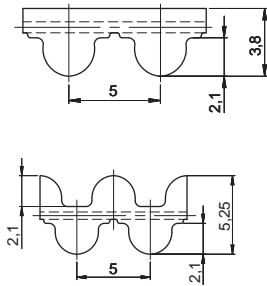
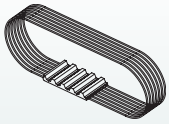

Belt characteristics

- Truly endless polyurethane timing belt with round tooth profile and steel tension cords
- Tooth profile according to ISO 13050
- Metric pitch 5 mm
- The round tooth profile allows a uniform load distribution that guarantees high performance, high transmissible torque and precise tooth engagement
- Transmissible power up to 6 kW
- Rpm up to 10.000 [1/min]
- **Dual tothing available from 1500 mm**

- Maximum width: 150 [mm]
- Width tolerance: ±0,5 [mm]
- Thickness tolerance: ±0,2 [mm]

Technical Data

Belt width [mm]	10	15	25	50	100	150
Allowable tensile load [N]	805	1265	2070	4255	8510	12765
Weight [kg/m]	0,05	0,07	0,11	0,23	0,46	0,68

Other widths are available on request.

Tooth shear strength

rpm [min ⁻¹]	M _{spez} [Ncm/cm]	P _{spez} [W/cm]	rpm [min ⁻¹]	M _{spez} [Ncm/cm]	P _{spez} [W/cm]	rpm [min ⁻¹]	M _{spez} [Ncm/cm]	P _{spez} [W/cm]
0	2,928	0,000	1200	1,992	2,503	3400	1,461	5,203
20	2,885	0,060	1300	1,955	2,661	3600	1,430	5,390
40	2,845	0,119	1400	1,920	2,814	3800	1,400	5,570
60	2,809	0,176	1440	1,906	2,875	4000	1,371	5,743
80	2,776	0,233	1500	1,887	2,964	4500	1,305	6,148
100	2,747	0,288	1600	1,855	3,109	5000	1,245	6,517
200	2,637	0,552	1700	1,826	3,250	5500	1,190	6,854
300	2,457	0,772	1800	1,797	3,387	6000	1,140	7,161
400	2,395	1,003	1900	1,770	3,521	6500	1,093	7,440
500	2,333	1,221	2000	1,744	3,652	7000	1,050	7,695
600	2,273	1,428	2200	1,695	3,904	7500	1,009	7,926
700	2,217	1,625	2400	1,649	4,145	8000	0,971	8,135
800	2,166	1,814	2600	1,607	4,375	8500	0,935	8,324
900	2,118	1,996	2800	1,567	4,595	9000	0,901	8,493
1000	2,073	2,170	3000	1,530	4,806	9500	0,869	8,644
1100	2,031	2,339	3200	1,495	5,009	10000	0,838	8,778

The total power "P" and the total torque "M" transmitted by the belt, are calculated with the following formulas:

$$P \text{ [kW]} = P_{\text{spez}} \cdot Z_e \cdot Z_k \cdot b / 1000$$

$$M \text{ [Nm]} = M_{\text{spez}} \cdot Z_e \cdot Z_k \cdot b / 100$$

$$Z_e = \frac{Z_k \cdot \arccos \left[\frac{t \cdot (Z_g - Z_k)}{2 \cdot \pi \cdot A} \right]}{180}$$

- P = power in kW
- M = torque in Nm
- P_{spez} = specific power
- M_{spez} = specific torque
- Z_e = number of teeth in mesh of the small pulley
- Z_{emax} = 12
- Z_k = number of teeth of the small pulley
- b = belt width in cm
- A = centre distance [mm]
- t = pitch

Flexibility

Minimum pulley number of teeth and minimum idler diameter			
Drive without reverse bending		Timing pulley Z _{min}	16
		Flat idler running on belt teeth d _{min}	30 mm
Drive with reverse bending		Timing pulley Z _{min}	25
		Flat idler running on belt back d _{min}	60 mm

Minimum available length

Execution	Max width	
	100 mm	150 mm
Standard	≥ 800 mm	≥ 1500 mm
PAZ	≥ 800 mm	≥ 1800 mm

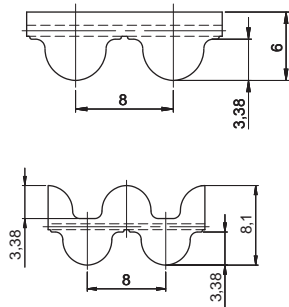
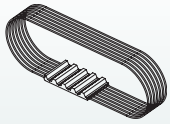

Belt characteristics

- Truly endless polyurethane timing belt with round tooth profile and steel tension cords
- Tooth profile according to ISO 13050
- Metric pitch 8 mm
- The round tooth profile allows a uniform load distribution that guarantees high performance, high transmissible torque and precise tooth engagement
- Transmissible power up to 80 kW
- Rpm up to 6.000 [1/min]
- **Dual toothing available from 1500 mm**

- Maximum width: 150 [mm]
- Width tolerance: ±0,5 [mm]
- Thickness tolerance: ±0,2 [mm]

Technical Data

Belt width [mm]	10	15	20	30	50	85	100	150
Allowable tensile load [N]	1470	2205	2940	4410	7350	12495	14700	22050
Weight [kg/m]	0,07	0,10	0,13	0,20	0,33	0,56	0,66	1,00

Other widths are available on request.

Tooth shear strength

rpm [min ⁻¹]	M _{spez} [Ncm/cm]	P _{spez} [W/cm]	rpm [min ⁻¹]	M _{spez} [Ncm/cm]	P _{spez} [W/cm]	rpm [min ⁻¹]	M _{spez} [Ncm/cm]	P _{spez} [W/cm]
0	9,422	0,000	1200	5,848	7,348	3400	3,936	14,013
20	9,246	0,194	1300	5,709	7,772	3600	3,826	14,421
40	9,083	0,380	1400	5,580	8,180	3800	3,721	14,805
60	8,933	0,561	1440	5,530	8,338	4000	3,621	15,166
80	8,794	0,737	1500	5,458	8,572	4500	3,390	15,975
100	8,666	0,907	1600	5,343	8,951	5000	3,183	16,663
200	8,160	1,709	1700	5,233	9,316	5500	2,994	17,241
300	7,853	2,467	1800	5,130	9,669	6000	2,821	17,720
400	7,516	3,148	1900	5,031	10,010	-	-	-
500	7,220	3,780	2000	4,937	10,340	-	-	-
600	6,959	4,372	2200	4,761	10,968	-	-	-
700	6,728	4,931	2400	4,599	11,557	-	-	-
800	6,519	5,461	2600	4,448	12,110	-	-	-
900	6,330	5,965	2800	4,308	12,630	-	-	-
1000	6,156	6,446	3000	4,176	13,119	-	-	-
1100	5,996	6,907	3200	4,053	13,580	-	-	-

The total power "P" and the total torque "M" transmitted by the belt, are calculated with the following formulas:

$$P \text{ [kW]} = P_{spez} \cdot Z_e \cdot Z_k \cdot b / 1000$$

$$M \text{ [Nm]} = M_{spez} \cdot Z_e \cdot Z_k \cdot b / 100$$

$$Z_e = \frac{Z_k}{180} \cdot \arccos \left[\frac{t \cdot (Z_g - Z_k)}{2 \cdot \pi \cdot A} \right]$$

- P = power in kW
- M = torque in Nm
- P_{spez} = specific power
- M_{spez} = specific torque
- Z_e = number of teeth in mesh of the small pulley
- Z_{emax} = 12
- Z_k = number of teeth of the small pulley
- b = belt width in cm
- A = centre distance [mm]
- t = pitch

Flexibility

Minimum pulley number of teeth and minimum idler diameter			
Drive without reverse bending		Timing pulley Z _{min}	18
		Flat idler running on belt teeth d _{min}	50 mm
Drive with reverse bending		Timing pulley Z _{min}	30
		Flat idler running on belt back d _{min}	120 mm

Minimum available length

Execution	Max width	
	100 mm	150 mm
Standard	≥ 800 mm	≥ 1500 mm
PAZ	≥ 800 mm	≥ 1800 mm

ELA-flex SD® HTD 14M

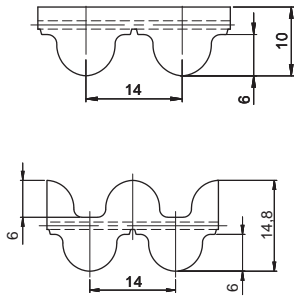
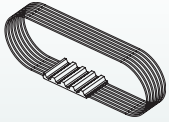

Belt characteristics

- Truly endless polyurethane timing belt with round tooth profile and steel tension cords
- Tooth profile according to ISO 13050
- Metric pitch 14 mm
- The round tooth profile allows a uniform load distribution that guarantees high performance, high transmissible torque and precise tooth engagement
- Transmissible power up to 200 kW
- Rpm up to 4.000 [1/min]
- **Dual tothing available from 1500 mm**

- Maximum width: 150 [mm]
- Width tolerance: ±1,0 [mm]
- Thickness tolerance: ±0,2 [mm]

Technical Data

Belt width [mm]	40	55	85	115	150
Allowable tensile load [N]	8640	12000	18720	24960	32640
Weight [kg/m]	0,42	0,57	0,89	1,24	1,70

Other widths are available on request.

Tooth shear strength

rpm [min ⁻¹]	M _{spez} [Ncm/cm]	P _{spez} [W/cm]	rpm [min ⁻¹]	M _{spez} [Ncm/cm]	P _{spez} [W/cm]	rpm [min ⁻¹]	M _{spez} [Ncm/cm]	P _{spez} [W/cm]
0	28,966	0,000	1200	16,335	20,526	3400	9,630	34,286
20	28,452	0,596	1300	15,852	21,578	3600	9,242	34,837
40	27,978	1,172	1400	15,398	22,573	3800	8,872	35,303
60	27,540	1,730	1440	15,225	22,957	4000	8,521	35,688
80	27,136	2,273	1500	14,972	23,516	-	-	-
100	26,762	2,802	1600	14,569	24,408	-	-	-
200	24,458	5,122	1700	14,187	25,254	-	-	-
300	23,239	7,300	1800	13,824	26,056	-	-	-
400	22,100	9,257	1900	13,478	26,816	-	-	-
500	21,091	11,042	2000	13,148	27,536	-	-	-
600	20,195	12,688	2200	12,530	28,865	-	-	-
700	19,394	14,216	2400	11,960	30,056	-	-	-
800	18,672	15,641	2600	11,431	31,121	-	-	-
900	18,014	16,976	2800	10,938	32,069	-	-	-
1000	17,410	18,230	3000	10,476	32,908	-	-	-
1100	16,853	19,411	3200	10,041	33,645	-	-	-

The total power "P" and the total torque "M" transmitted by the belt, are calculated with the following formulas:

$$P \text{ [kW]} = P_{\text{spez}} \cdot Z_e \cdot Z_k \cdot b / 1000$$

$$M \text{ [Nm]} = M_{\text{spez}} \cdot Z_e \cdot Z_k \cdot b / 100$$

$$Z_e = \frac{Z_k}{180} \cdot \arccos \left[\frac{t \cdot (Z_g - Z_k)}{2 \cdot \pi \cdot A} \right]$$

P = power in kW

M = torque in Nm

P_{spez} = specific power

M_{spez} = specific torque

Z_e = number of teeth in mesh of the small pulley

Z_{emax} = 12

Z_k = number of teeth of the small pulley

b = belt width in cm

A = centre distance [mm]

t = pitch

Flexibility

Minimum pulley number of teeth and minimum idler diameter			
Drive without reverse bending		Timing pulley Z _{min}	28
		Flat idler running on belt teeth d _{min}	120 mm
Drive with reverse bending		Timing pulley Z _{min}	28
		Flat idler running on belt back d _{min}	180 mm

Minimum available length

Execution	Max width 150 mm
Standard	≥ 1500 mm
PAZ	≥ 1800 mm

ELA-flex SD® RTD 5M

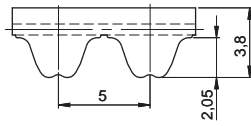
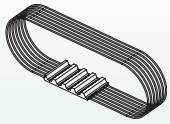

Belt characteristics

- Truly endless polyurethane timing belt with round tooth profile and steel tension cords
- Tooth profile according to ISO 13050
- Metric pitch 5 mm
- PAZ fabric on tooth delivered as standard decreases noise in high speed drives
- Transmissible power up to 6 kW
- Rpm up to 10.000 [1/min]

- Maximum width: 150 [mm]
- Width tolerance: ±0,5 [mm]
- Thickness tolerance: ±0,2 [mm]

Technical Data

Belt width [mm]	10	15	25	50	100	150
Allowable tensile load [N]	805	1265	2070	4255	8510	12765
Weight [kg/m]	0,05	0,07	0,11	0,23	0,46	0,69

Other widths are available on request.

Tooth shear strength

rpm [min ⁻¹]	M _{spez} [Ncm/cm]	P _{spez} [W/cm]	rpm [min ⁻¹]	M _{spez} [Ncm/cm]	P _{spez} [W/cm]	rpm [min ⁻¹]	M _{spez} [Ncm/cm]	P _{spez} [W/cm]
0	3,01	0,000	1200	2,15	2,703	3400	1,62	5,770
20	2,96	0,062	1300	2,11	2,878	3600	1,59	5,990
40	2,92	0,122	1400	2,08	3,048	3800	1,56	6,203
60	2,89	0,181	1440	2,07	3,115	4000	1,53	6,410
80	2,86	0,239	1500	2,05	3,214	4500	1,46	6,898
100	2,83	0,296	1600	2,01	3,375	5000	1,40	7,351
200	2,72	0,569	1700	1,98	3,533	5500	1,35	7,770
300	2,62	0,822	1800	1,96	3,687	6000	1,30	8,161
400	2,55	1,070	1900	1,93	3,838	6500	1,25	8,524
500	2,49	1,305	2000	1,90	3,985	7000	1,21	8,861
600	2,43	1,528	2200	1,85	4,271	7500	1,17	9,176
700	2,38	1,742	2400	1,81	4,545	8000	1,13	9,468
800	2,32	1,947	2600	1,77	4,808	8500	1,09	9,740
900	2,28	2,146	2800	1,73	5,062	9000	1,06	9,993
1000	2,23	2,337	3000	1,69	5,306	9500	1,03	10,228
1100	2,19	2,523	3200	1,65	5,542	10000	1,00	10,445

The total power "P" and the total torque "M" transmitted by the belt, are calculated with the following formulas:

$$P \text{ [kW]} = P_{\text{spez}} \cdot Z_e \cdot Z_k \cdot b / 1000$$

$$M \text{ [Nm]} = M_{\text{spez}} \cdot Z_e \cdot Z_k \cdot b / 100$$

$$Z_e = \frac{Z_k \cdot \arccos \left[\frac{t \cdot (Z_g - Z_k)}{2 \cdot \pi \cdot A} \right]}{180}$$

P = power in kW

M = torque in Nm

P_{spez} = specific power

M_{spez} = specific torque

Z_e = number of teeth in mesh of the small pulley

Z_{emax} = 12

Z_k = number of teeth of the small pulley

b = belt width in cm

A = centre distance [mm]

t = pitch

Flexibility

Minimum pulley number of teeth and minimum idler diameter			
Drive without reverse bending		Timing pulley Z _{min}	16
		Flat idler running on belt teeth d _{min}	30 mm
Drive with reverse bending		Timing pulley Z _{min}	25
		Flat idler running on belt back d _{min}	60 mm

Minimum available length

Execution	Max width 100 mm
Standard	≥ 1500 mm
PAZ	≥ 1800 mm

ELA-flex SD® RTD 8M

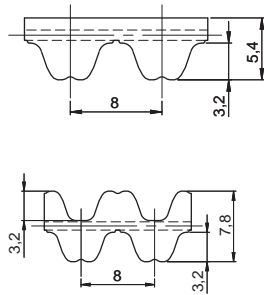
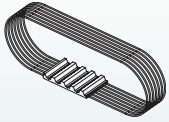

Belt characteristics

- Truly endless polyurethane timing belt with round tooth profile and steel tension cords
- Tooth profile according to ISO 13050
- Metric pitch 8 mm
- PAZ fabric on tooth delivered as standard decreases noise in high speed drives
- Transmissible power up to 80 kW
- Rpm up to 6.000 [1/min]
- **Dual tothing available from 1500 mm**

- Maximum width: 150 [mm]
- Width tolerance: ±0,5 [mm]
- Thickness tolerance: ±0,2 [mm]

Technical Data

Belt width [mm]	10	15	20	30	50	85	100	150
Allowable tensile load [N]	1470	2205	2940	4410	7350	12495	14700	22050
Weight [kg/m]	0,07	0,10	0,13	0,20	0,33	0,56	0,66	1,00

Other widths are available on request.

Tooth shear strength

rpm [min ⁻¹]	M _{spez} [Ncm/cm]	P _{spez} [W/cm]	rpm [min ⁻¹]	M _{spez} [Ncm/cm]	P _{spez} [W/cm]	rpm [min ⁻¹]	M _{spez} [Ncm/cm]	P _{spez} [W/cm]
0	9,68	0,000	1200	6,10	7,668	3400	4,19	14,920
20	9,50	0,199	1300	5,96	8,118	3600	4,08	15,381
40	9,34	0,391	1400	5,83	8,553	3800	3,98	15,818
60	9,19	0,577	1440	5,78	8,722	4000	3,88	16,232
80	9,05	0,758	1500	5,71	8,972	4500	3,64	17,175
100	8,92	0,934	1600	5,60	9,377	5000	3,44	17,996
200	8,41	1,762	1700	5,49	9,769	5500	3,25	18,708
300	8,11	2,547	1800	5,38	10,149	6000	3,08	19,320
400	7,77	3,255	1900	5,29	10,517	-	-	-
500	7,47	3,913	2000	5,19	10,873	-	-	-
600	7,21	4,532	2200	5,02	11,554	-	-	-
700	6,98	5,118	2400	4,85	12,197	-	-	-
800	6,77	5,674	2600	4,70	12,803	-	-	-
900	6,58	6,205	2800	4,56	13,377	-	-	-
1000	6,41	6,713	3000	4,43	13,919	-	-	-
1100	6,25	7,200	3200	4,31	14,433	-	-	-

The total power "P" and the total torque "M" transmitted by the belt, are calculated with the following formulas:

$$P \text{ [kW]} = P_{\text{spez}} \cdot z_e \cdot z_k \cdot b / 1000$$

$$M \text{ [Nm]} = M_{\text{spez}} \cdot z_e \cdot z_k \cdot b / 100$$

$$z_e = \frac{z_k \cdot \arccos\left[\frac{t \cdot (z_g - z_k)}{2 \cdot \pi \cdot A}\right]}{180}$$

P = power in kW

M = torque in Nm

P_{spez} = specific power

M_{spez} = specific torque

z_e = number of teeth in mesh of the small pulley

z_{emax} = 12

z_k = number of teeth of the small pulley

b = belt width in cm

A = centre distance [mm]

t = pitch

Flexibility

Minimum pulley number of teeth and minimum idler diameter			
Drive without reverse bending		Timing pulley z _{min}	18
		Flat idler running on belt teeth d _{min}	50 mm
Drive with reverse bending		Timing pulley z _{min}	30
		Flat idler running on belt back d _{min}	120 mm

Minimum available length

Execution	Max width	
	100 mm	150 mm
Standard	≥ 800 mm	≥ 1500 mm
PAZ	≥ 800 mm	≥ 1800 mm

ELA-flex SD® RTD 14M

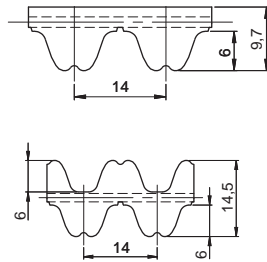
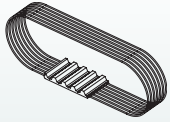

Belt characteristics

- Truly endless polyurethane timing belt with round tooth profile and steel tension cords
- Tooth profile according to ISO 13050
- Metric pitch 14 mm
- PAZ fabric on tooth delivered as standard decreases noise in high speed drives
- Transmissible power up to 200 kW
- Rpm up to 4.000 [1/min]
- **Dual tooting available from 1500 mm**

- Maximum width: 150 [mm]
- Width tolerance: ±1,0 [mm]
- Thickness tolerance: ±0,2 [mm]

Technical Data

Belt width [mm]	40	55	85	115	150
Allowable tensile load [N]	13600	17850	28050	38250	49300
Weight [kg/m]	0,48	0,63	1,0	1,40	1,85

Other widths are available on request.

Tooth shear strength

rpm [min ⁻¹]	M _{spez} [Ncm/cm]	P _{spez} [W/cm]	rpm [min ⁻¹]	M _{spez} [Ncm/cm]	P _{spez} [W/cm]	rpm [min ⁻¹]	M _{spez} [Ncm/cm]	P _{spez} [W/cm]
0	31,19	0,000	1200	18,56	23,325	3400	11,86	42,219
20	30,59	0,641	1300	18,08	24,611	3600	11,47	43,237
40	30,04	1,258	1400	17,63	25,840	3800	11,10	44,169
60	29,53	1,855	1440	17,45	26,316	4000	10,75	45,021
80	29,06	2,434	1500	17,20	27,016	-	-	-
100	28,62	2,997	1600	16,80	28,141	-	-	-
200	26,69	5,589	1700	16,42	29,220	-	-	-
300	25,47	8,000	1800	16,05	30,255	-	-	-
400	24,33	10,190	1900	15,71	31,249	-	-	-
500	23,32	12,209	2000	15,38	32,202	-	-	-
600	22,42	14,088	2200	14,76	33,998	-	-	-
700	21,62	15,849	2400	14,19	35,656	-	-	-
800	20,90	17,508	2600	13,66	37,187	-	-	-
900	20,24	19,076	2800	13,17	38,602	-	-	-
1000	19,64	20,564	3000	12,70	39,907	-	-	-
1100	19,08	21,978	3200	12,27	41,111	-	-	-

The total power "P" and the total torque "M" transmitted by the belt, are calculated with the following formulas:

$$P \text{ [kW]} = P_{\text{spez}} \cdot Z_e \cdot Z_k \cdot b / 1000$$

$$M \text{ [Nm]} = M_{\text{spez}} \cdot Z_e \cdot Z_k \cdot b / 100$$

$$Z_e = \frac{Z_k}{180} \cdot \arccos \left[\frac{t \cdot (Z_g - Z_k)}{2 \cdot \pi \cdot A} \right]$$

P = power in kW

M = torque in Nm

P_{spez} = specific power

M_{spez} = specific torque

Z_e = number of teeth in mesh of the small pulley

Z_{emax} = 12

Z_k = number of teeth of the small pulley

b = belt width in cm

A = centre distance [mm]

t = pitch

Flexibility

Minimum pulley number of teeth and minimum idler diameter			
Drive without reverse bending		Timing pulley Z _{min}	32
		Flat idler running on belt teeth d _{min}	140 mm
Drive with reverse bending		Timing pulley Z _{min}	32
		Flat idler running on belt back d _{min}	200 mm

Minimum available length

Execution	Max width 150 mm
Standard	≥ 1500 mm
PAZ	≥ 1800 mm

ELA-flex SD® STD 5M

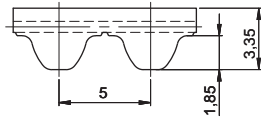
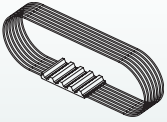

Belt characteristics

- Truly endless polyurethane timing belt with high tensile load steel cords and high torque capacity
- Tooth profile according to ISO 13050
- Metric pitch 5 mm
- Low noise generation in high speed drives
- Offer excellent operational reliability
- The special profile allows smooth running properties
- Transmissible power up to 6 Kw
- Rpm up to 10.000 [1/min]

- Maximum width: 150 [mm]
- Width tolerance: ±0,5 [mm]
- Thickness tolerance: ±0,2 [mm]

Technical Data

Belt width [mm]	10	15	25	50	100	150
Allowable tensile load [N]	805	1265	2070	4255	8510	12765
Weight [kg/m]	0,046	0,068	0,114	0,228	0,456	1,368

Other widths are available on request.

Tooth shear strength

rpm [min ⁻¹]	M _{spez} [Ncm/cm]	P _{spez} [W/cm]	rpm [min ⁻¹]	M _{spez} [Ncm/cm]	P _{spez} [W/cm]	rpm [min ⁻¹]	M _{spez} [Ncm/cm]	P _{spez} [W/cm]
0	2,936	0,000	1200	2,031	2,553	3400	1,501	5,345
20	2,892	0,061	1300	1,995	2,715	3600	1,470	5,540
40	2,853	0,119	1400	1,960	2,873	3800	1,440	5,728
60	2,817	0,177	1440	1,946	2,935	4000	1,411	5,910
80	2,784	0,233	1500	1,927	3,026	4500	1,345	6,336
100	2,755	0,288	1600	1,895	3,175	5000	1,285	6,726
200	2,645	0,554	1700	1,865	3,321	5500	1,230	7,083
300	2,497	0,784	1800	1,837	3,462	6000	1,180	7,411
400	2,435	1,020	1900	1,810	3,600	6500	1,133	7,711
500	2,372	1,242	2000	1,784	3,735	7000	1,090	7,987
600	2,313	1,453	2200	1,734	3,996	7500	1,049	8,238
700	2,257	1,654	2400	1,689	4,245	8000	1,011	8,469
800	2,205	1,847	2600	1,647	4,483	8500	0,975	8,678
900	2,157	2,033	2800	1,607	4,712	9000	0,941	8,868
1000	2,113	2,212	3000	1,570	4,931	9500	0,909	9,040
1100	2,071	2,385	3200	1,535	5,142	10000	0,878	9,195

The total power "P" and the total torque "M" transmitted by the belt, are calculated with the following formulas:

$$P \text{ [kW]} = P_{\text{spez}} \cdot Z_e \cdot Z_k \cdot b / 1000$$

$$M \text{ [Nm]} = M_{\text{spez}} \cdot Z_e \cdot Z_k \cdot b / 100$$

$$Z_e = \frac{Z_k \cdot \arccos \left[\frac{t \cdot (Z_g - Z_k)}{2 \cdot \pi \cdot A} \right]}{180}$$

- P = power in kW
- M = torque in Nm
- P_{spez} = specific power
- M_{spez} = specific torque
- Z_e = number of teeth in mesh of the small pulley
- Z_{emax} = 12
- Z_k = number of teeth of the small pulley
- b = belt width in cm
- A = centre distance [mm]
- t = pitch

Flexibility

Minimum pulley number of teeth and minimum idler diameter			
Drive without reverse bending		Timing pulley Z _{min}	16
		Flat idler running on belt teeth d _{min}	30 mm
Drive with reverse bending		Timing pulley Z _{min}	25
		Flat idler running on belt back d _{min}	60 mm

Minimum available length

Execution	Max width	
	100 mm	150 mm
Standard	≥ 800 mm	≥ 1500 mm
PAZ	≥ 800 mm	≥ 1800 mm

ELA-flex SD® STD 8M

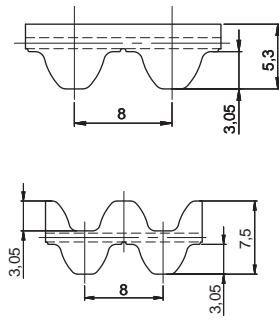
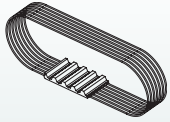

Belt characteristics

- Truly endless polyurethane timing belt with high tensile load steel cords and high torque capacity
- Tooth profile according to ISO 13050
- Metric pitch 8 mm
- Low noise generation in high speed drives
- Offer excellent operational reliability
- The special profile allows smooth running properties
- Transmissible power up to 80 Kw
- Rpm up to 6.000 [1/min]
- **Dual tothing available from 1500 mm**

- Maximum width: 150 [mm]
- Width tolerance: ±0,5 [mm]
- Thickness tolerance: ±0,2 [mm]

Technical Data

Belt width [mm]	10	15	20	30	50	85	100	150
Allowable tensile load [N]	1470	2205	2940	4410	7350	12495	14700	22050
Weight [kg/m]	0,07	0,10	0,13	0,20	0,33	0,56	0,66	1,00

Other widths are available on request.

Tooth shear strength

rpm [min ⁻¹]	M _{spez} [Ncm/cm]	P _{spez} [W/cm]	rpm [min ⁻¹]	M _{spez} [Ncm/cm]	P _{spez} [W/cm]	rpm [min ⁻¹]	M _{spez} [Ncm/cm]	P _{spez} [W/cm]
0	9,435	0,000	1200	5,885	7,394	3400	3,960	14,098
20	9,301	0,195	1300	5,745	7,821	3600	3,849	14,508
40	9,176	0,384	1400	5,615	8,231	3800	3,743	14,894
60	9,057	0,569	1440	5,565	8,391	4000	3,643	15,257
80	8,946	0,749	1500	5,492	8,626	4500	3,410	16,070
100	8,841	0,926	1600	5,376	9,007	5000	3,201	16,762
200	8,401	1,759	1700	5,266	9,374	5500	3,011	17,343
300	7,908	2,484	1800	5,162	9,729	6000	2,837	17,824
400	7,567	3,169	1900	5,063	10,072	-	-	-
500	7,268	3,805	2000	4,968	10,404	-	-	-
600	7,005	4,401	2200	4,790	11,035	-	-	-
700	6,772	4,963	2400	4,627	11,628	-	-	-
800	6,561	5,496	2600	4,475	12,184	-	-	-
900	6,370	6,003	2800	4,334	12,707	-	-	-
1000	6,195	6,487	3000	4,202	13,199	-	-	-
1100	6,034	6,950	3200	4,077	13,662	-	-	-

The total power "P" and the total torque "M" transmitted by the belt, are calculated with the following formulas:

$$P \text{ [kW]} = P_{\text{spez}} \cdot Z_e \cdot Z_k \cdot b / 1000$$

$$M \text{ [Nm]} = M_{\text{spez}} \cdot Z_e \cdot Z_k \cdot b / 100$$

$$Z_e = \frac{Z_k}{180} \cdot \arccos \left[\frac{t \cdot (Z_g - Z_k)}{2 \cdot \pi \cdot A} \right]$$

P = power in kW

M = torque in Nm

P_{spez} = specific power

M_{spez} = specific torque

Z_e = number of teeth in mesh of the small pulley

Z_{emax} = 12

Z_k = number of teeth of the small pulley

b = belt width in cm

A = centre distance [mm]

t = pitch

Flexibility

Minimum pulley number of teeth and minimum idler diameter			
Drive without reverse bending		Timing pulley Z _{min}	18
		Flat idler running on belt teeth d _{min}	50 mm
Drive with reverse bending		Timing pulley Z _{min}	30
		Flat idler running on belt back d _{min}	120 mm

Minimum available length

Execution	Max width 150 mm
Standard	≥ 1500 mm
PAZ	≥ 1800 mm

ELA-flex SD® STD 14M

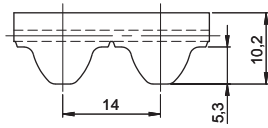
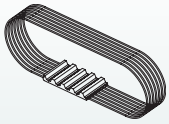

Belt characteristics

- Truly endless polyurethane timing belt with high tensile load steel cords and high torque capacity
- Tooth profile according to ISO 13050
- Metric pitch 14 mm
- Low noise generation in high speed drives
- Offer excellent operational reliability
- The special profile allows smooth running properties
- Transmissible power up to 200 Kw
- Rpm up to 4.000 [1/min]

- Maximum width: 100 [mm]
- Width tolerance: ±1,0 [mm]
- Thickness tolerance: ±0,2 [mm]

Technical Data

Belt width [mm]	40	55	85	100
Allowable tensile load [N]	13600	17850	28050	33150
Weight [kg/m]	0,48	0,85	1,10	1,54

Other widths are available on request.

Tooth shear strength

rpm [min ⁻¹]	M _{spez} [Ncm/cm]	P _{spez} [W/cm]	rpm [min ⁻¹]	M _{spez} [Ncm/cm]	P _{spez} [W/cm]	rpm [min ⁻¹]	M _{spez} [Ncm/cm]	P _{spez} [W/cm]
0	29,86	0,000	1200	17,45	21,925	3400	10,74	38,252
20	29,26	0,613	1300	16,97	23,095	3600	10,36	39,037
40	28,70	1,202	1400	16,51	24,207	3800	9,99	39,736
60	28,19	1,771	1440	16,34	24,636	4000	9,63	40,354
80	27,72	2,322	1500	16,09	25,266	-	-	-
100	27,29	2,857	1600	15,68	26,275	-	-	-
200	25,57	5,355	1700	15,30	27,237	-	-	-
300	24,35	7,650	1800	14,94	28,156	-	-	-
400	23,21	9,723	1900	14,59	29,032	-	-	-
500	22,20	11,626	2000	14,26	29,869	-	-	-
600	21,31	13,388	2200	13,64	31,431	-	-	-
700	20,51	15,032	2400	13,07	32,856	-	-	-
800	19,79	16,575	2600	12,55	34,154	-	-	-
900	19,13	18,026	2800	12,05	35,335	-	-	-
1000	18,52	19,397	3000	11,59	36,408	-	-	-
1100	17,97	20,695	3200	11,15	37,378	-	-	-

The total power "P" and the total torque "M" transmitted by the belt, are calculated with the following formulas:

$$P \text{ [kW]} = P_{\text{spez}} \cdot Z_e \cdot Z_k \cdot b / 1000$$

$$M \text{ [Nm]} = M_{\text{spez}} \cdot Z_e \cdot Z_k \cdot b / 100$$

$$Z_e = \frac{Z_k}{180} \cdot \arccos \left[\frac{t \cdot (Z_g - Z_k)}{2 \cdot \pi \cdot A} \right]$$

P = power in kW

M = torque in Nm

P_{spez} = specific power

M_{spez} = specific torque

Z_e = number of teeth in mesh of the small pulley

Z_{emax} = 12

Z_k = number of teeth of the small pulley

b = belt width in cm

A = centre distance [mm]

t = pitch

Flexibility

Minimum pulley number of teeth and minimum idler diameter			
Drive without reverse bending		Timing pulley Z _{min}	28
		Flat idler running on belt teeth d _{min}	120 mm
Drive with reverse bending		Timing pulley Z _{min}	28
		Flat idler running on belt back d _{min}	180 mm

Minimum available length

Execution	Max width 100 mm
Standard	≥ 1500 mm
PAZ	≥ 1800 mm

ELA-flex SD® EAGLE 5M

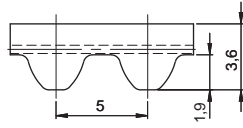

Belt characteristics

- Truly endless polyurethane timing belt with helical offset tooth, high tensile load steel cords and high torque capacity
- **Self tracking no need of pulley flanges**
- Metric pitch 5 mm
- **Extremely reduced noise generation**
- The special profile allows most compact drive
- **Max. length 2400 mm**

• Maximum width:	25 [mm]
• Width tolerance:	±0,8 [mm]
• Thickness tolerance:	±0,2 [mm]

Technical Data

Belt width [mm]	12,5	25
Allowable tensile load [N]	1150	2530
Weight [kg/m]	0,06	0,12

Other widths are available on request.

Tooth shear strength

rpm [min ⁻¹]	M _{spez} [Ncm/cm]	P _{spez} [W/cm]	rpm [min ⁻¹]	M _{spez} [Ncm/cm]	P _{spez} [W/cm]	rpm [min ⁻¹]	M _{spez} [Ncm/cm]	P _{spez} [W/cm]
0	3,01	0,000	1200	2,15	2,702	3400	1,62	5,768
20	2,96	0,062	1300	2,11	2,872	3600	1,59	5,994
40	2,92	0,122	1400	2,08	3,049	3800	1,56	6,208
60	2,89	0,182	1440	2,07	3,121	4000	1,53	6,409
80	2,86	0,240	1500	2,05	3,220	4500	1,46	6,880
100	2,83	0,296	1600	2,01	3,368	5000	1,40	7,330
200	2,72	0,570	1700	1,98	3,525	5500	1,35	7,775
300	2,62	0,823	1800	1,96	3,695	6000	1,30	8,168
400	2,55	1,068	1900	1,93	3,840	6500	1,25	8,508
500	2,49	1,304	2000	1,90	3,979	-	-	-
600	2,43	1,527	2200	1,85	4,262	-	-	-
700	2,38	1,745	2400	1,81	4,549	-	-	-
800	2,32	1,944	2600	1,77	4,819	-	-	-
900	2,28	2,149	2800	1,73	5,073	-	-	-
1000	2,23	2,335	3000	1,69	5,372	-	-	-
1100	2,19	2,523	3200	1,65	5,663	-	-	-

The total power "P" and the total torque "M" transmitted by the belt, are calculated with the following formulas:

$$P \text{ [kW]} = P_{\text{spez}} \cdot Z_e \cdot Z_k \cdot b / 1000$$

$$M \text{ [Nm]} = M_{\text{spez}} \cdot Z_e \cdot Z_k \cdot b / 100$$

$$Z_e = \frac{Z_k}{180} \cdot \arccos \left[\frac{t \cdot (Z_g - Z_k)}{2 \cdot \pi \cdot A} \right]$$

P = power in kW

M = torque in Nm

P_{spez} = specific power

M_{spez} = specific torque

Z_e = number of teeth in mesh of the small pulley

Z_{emax} = 12

Z_k = number of teeth of the small pulley

b = belt width in cm

A = centre distance [mm]

t = pitch

Flexibility

Minimum pulley number of teeth and minimum idler diameter			
Drive without reverse bending		Timing pulley Z _{min}	16
		Flat idler running on belt teeth d _{min}	30 mm
Drive with reverse bending		Timing pulley Z _{min}	25
		Flat idler running on belt back d _{min}	60 mm

Minimum available length

Execution	Max width 25 mm
Standard	≥ 800 mm
PAZ	≥ 800 mm

ELA-flex SD® EAGLE 8M

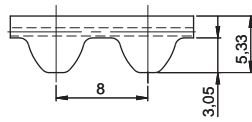

Belt characteristics

- Truly endless polyurethane timing belt with helical offset tooth, high tensile load steel cords and high torque capacity
- **Self tracking no need of pulley flanges**
- Metric pitch 8 mm
- **Extremely reduced noise generation**
- The special profile allows most compact drive

- Maximum width: 50 [mm]
- Width tolerance: ±0,8 [mm]
- Thickness tolerance: ±0,3 [mm]

Technical Data

Belt width [mm]	16	25	32	50
Allowable tensile load [N]	2430	4040	5120	8090
Weight [kg/m]	0,085	0,145	0,180	0,300

Other widths are available on request.

Tooth shear strength

rpm [min ⁻¹]	M _{spez} [Ncm/cm]	P _{spez} [W/cm]	rpm [min ⁻¹]	M _{spez} [Ncm/cm]	P _{spez} [W/cm]	rpm [min ⁻¹]	M _{spez} [Ncm/cm]	P _{spez} [W/cm]
0	10,82	0,000	1200	6,87	8,631	3400	4,90	16,422
20	10,67	0,223	1300	6,72	9,146	3600	4,77	16,991
40	10,52	0,441	1400	6,58	9,642	3800	4,65	17,531
60	10,38	0,652	1440	6,52	9,836	4000	4,53	18,044
80	10,24	0,858	1500	6,44	10,122	4500	4,42	18,531
100	10,11	1,058	1600	6,32	10,585	5000	4,17	19,647
200	9,52	1,994	1700	6,20	11,035	5500	3,94	20,627
300	9,04	2,840	1800	6,09	11,470	6000	3,73	21,486
400	8,65	3,623	1900	5,98	11,892	6500	3,54	22,234
500	8,34	4,368	2000	5,87	12,302	-	-	-
600	8,07	5,068	2200	5,68	13,087	-	-	-
700	7,82	5,732	2400	5,50	13,828	-	-	-
800	7,60	6,363	2600	5,34	14,529	-	-	-
900	7,39	6,966	2800	5,18	15,194	-	-	-
1000	7,20	7,543	3000	5,12	15,450	-	-	-
1100	7,03	8,098	3200	5,04	15,824	-	-	-

The total power "P" and the total torque "M" transmitted by the belt, are calculated with the following formulas:

$$P \text{ [kW]} = P_{\text{spez}} \cdot Z_e \cdot Z_k \cdot b / 1000$$

$$M \text{ [Nm]} = M_{\text{spez}} \cdot Z_e \cdot Z_k \cdot b / 100$$

$$Z_e = \frac{Z_k}{180} \cdot \arccos \left[\frac{t \cdot (Z_g - Z_k)}{2 \cdot \pi \cdot A} \right]$$

P = power in kW

M = torque in Nm

P_{spez} = specific power

M_{spez} = specific torque

Z_e = number of teeth in mesh of the small pulley

Z_{emax} = 12

Z_k = number of teeth of the small pulley

b = belt width in cm

A = centre distance [mm]

t = pitch

Flexibility

Minimum pulley number of teeth and minimum idler diameter			
Drive without reverse bending		Timing pulley Z _{min}	20
		Flat idler running on belt teeth d _{min}	50 mm
Drive with reverse bending		Timing pulley Z _{min}	30
		Flat idler running on belt back d _{min}	120 mm

Minimum available length

Execution	Max width 50 mm
Standard	≥ 900 mm
PAZ	≥ 900 mm

ELA-flex SD® EAGLE 10M

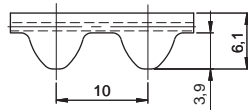

Belt characteristics

- Truly endless polyurethane timing belt with helical offset tooth, high tensile load steel cords and high torque capacity
- **Self tracking no need of pulley flanges**
- Metric pitch 10 mm
- **Extremely reduced noise generation**
- The special profile allows most compact drive

- Maximum width: 50 [mm]
- Width tolerance: ±0,8 [mm]
- Thickness tolerance: ±0,3 [mm]

Technical Data

Belt width [mm]	25	32	50
Allowable tensile load [N]	5810	7920	12140
Weight [kg/m]	0,18	0,23	0,37

Other widths are available on request.

Tooth shear strength

rpm [min ⁻¹]	M _{spez} [Ncm/cm]	P _{spez} [W/cm]	rpm [min ⁻¹]	M _{spez} [Ncm/cm]	P _{spez} [W/cm]	rpm [min ⁻¹]	M _{spez} [Ncm/cm]	P _{spez} [W/cm]
0	14,881	0,000	1200	9,273	11,653	3400	6,443	22,937
20	14,647	0,307	1300	9,070	12,347	3600	6,278	23,666
40	14,424	0,604	1400	8,879	13,017	3800	6,122	24,359
60	14,210	0,893	1440	8,806	13,278	4000	5,973	25,017
80	14,005	1,173	1500	8,699	13,664	4500	5,629	26,523
100	13,809	1,446	1600	8,530	14,290	5000	5,319	27,847
200	12,949	2,712	1700	8,369	14,897	5500	5,036	29,006
300	12,259	3,851	1800	8,215	15,485	6000	4,778	30,016
400	11,705	4,903	1900	8,070	16,055	6500	4,540	30,890
500	11,263	5,897	2000	7,930	16,608	7000	4,320	31,630
600	10,890	6,842	2200	7,669	17,667	7500	4,110	32,260
700	10,556	7,738	2400	7,428	18,668	8000	3,910	32,780
800	10,254	8,590	2600	7,205	19,615	8500	3,730	33,190
900	9,979	9,404	2800	6,996	20,512	9000	3,560	33,510
1000	9,725	10,184	3000	6,800	21,363	9500	3,390	33,740
1100	9,491	10,932	3200	6,616	22,170	10000	3,230	33,870

The total power "P" and the total torque "M" transmitted by the belt, are calculated with the following formulas:

$$P \text{ [kW]} = P_{\text{spez}} \cdot Z_e \cdot Z_k \cdot b / 1000$$

$$M \text{ [Nm]} = M_{\text{spez}} \cdot Z_e \cdot Z_k \cdot b / 100$$

$$Z_e = \frac{Z_k \cdot \arccos \left[\frac{t \cdot (Z_g - Z_k)}{2 \cdot \pi \cdot A} \right]}{180}$$

P = power in kW

M = torque in Nm

P_{spez} = specific power

M_{spez} = specific torque

Z_e = number of teeth in mesh of the small pulley

Z_{emax} = 12

Z_k = number of teeth of the small pulley

b = belt width in cm

A = centre distance [mm]

t = pitch

Flexibility

Minimum pulley number of teeth and minimum idler diameter			
Drive without reverse bending		Timing pulley Z _{min}	25
		Flat idler running on belt teeth d _{min}	80 mm
Drive with reverse bending		Timing pulley Z _{min}	25
		Flat idler running on belt back d _{min}	150 mm

Minimum available length

Execution	Max width 50 mm
Standard	≥ 900 mm
PAZ	≥ 900 mm

ELA-flex SD® EAGLE 14M

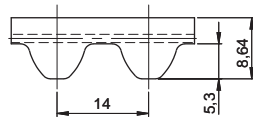

Belt characteristics

- Truly endless polyurethane timing belt with helical offset tooth, high tensile load steel cords and high torque capacity
- **Self tracking no need of pulley flanges**
- Metric pitch 14 mm
- **Extremely reduced noise generation**
- The special profile allows most compact drive

- Maximum width: 105 [mm]
- Width tolerance: ±1,2 [mm]
- Thickness tolerance: ±0,4 [mm]

Technical Data

Belt width [mm]	35	52,5	70	105
Allowable tensile load [N]	13090	18700	26180	39270
Weight [kg/m]	0,4	0,6	0,8	1,2

Other widths are available on request.

Tooth shear strength

rpm [min ⁻¹]	M _{spez} [Ncm/cm]	P _{spez} [W/cm]	rpm [min ⁻¹]	M _{spez} [Ncm/cm]	P _{spez} [W/cm]	rpm [min ⁻¹]	M _{spez} [Ncm/cm]	P _{spez} [W/cm]
0	35,65	0,000	1200	20,07	25,222	3200	12,19	40,849
20	34,98	0,733	1300	19,46	26,495	3400	11,68	41,581
40	34,36	1,439	1400	18,89	27,698	3600	11,19	42,201
60	33,79	2,123	1440	18,68	28,160	3800	10,73	42,715
80	33,25	2,786	1500	18,36	28,834	4000	10,30	43,129
100	32,76	3,430	1600	17,85	29,909	-	-	-
200	30,76	6,441	1700	17,37	30,926	-	-	-
300	28,94	9,090	1800	16,92	31,888	-	-	-
400	27,43	11,491	1900	16,49	32,798	-	-	-
500	26,12	13,677	2000	16,07	33,659	-	-	-
600	24,97	15,689	2200	15,30	35,243	-	-	-
700	23,95	17,553	2400	14,59	36,656	-	-	-
800	23,03	19,290	2600	13,93	37,912	-	-	-
900	22,19	20,915	2800	13,31	39,023	-	-	-
1000	21,43	22,439	2880	13,07	39,429	-	-	-
1100	20,73	23,872	3000	12,73	39,999	-	-	-

The total power "P" and the total torque "M" transmitted by the belt, are calculated with the following formulas:

$$P \text{ [kW]} = P_{\text{spez}} \cdot Z_e \cdot Z_k \cdot b / 1000$$

$$M \text{ [Nm]} = M_{\text{spez}} \cdot Z_e \cdot Z_k \cdot b / 100$$

$$Z_e = \frac{Z_k}{180} \cdot \arccos \left[\frac{t \cdot (Z_g - Z_k)}{2 \cdot \pi \cdot A} \right]$$

P = power in kW

M = torque in Nm

P_{spez} = specific power

M_{spez} = specific torque

Z_e = number of teeth in mesh of the small pulley

Z_{emax} = 12

Z_k = number of teeth of the small pulley

b = belt width in cm

A = centre distance [mm]

t = pitch

Flexibility

Minimum pulley number of teeth and minimum idler diameter			
Drive without reverse bending		Timing pulley Z _{min}	32
		Flat idler running on belt teeth d _{min}	140 mm
Drive with reverse bending		Timing pulley Z _{min}	32
		Flat idler running on belt back d _{min}	200 mm

Minimum available length

Execution	Max width 105 mm
Standard	≥ 1800 mm
PAZ	≥ 1800 mm

ELA-flex SD® AT K5 - K6

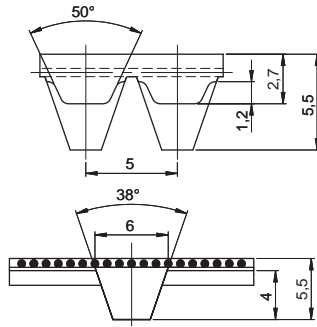
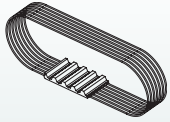

Belt characteristics

- Polyurethane self tracking timing belt with steel tension cords
- Tooth profile according to ISO 17396
- Profile AT5 with central guide - K6 x 4 mm
- Central guide height 4,0 mm
- Allow to use pulleys without flanges
- The central guide is notched in order to maximize belt flexibility
- Ideal for conveying applications where a side load is generated by loading/unloading transferring a product
- **Max length 2500mm**
- **Dual toothing available from 1500 mm**

- Maximum width: 50 [mm]
- Width tolerance: ±0,5 [mm]
- Thickness tolerance: ±0,2 [mm]

Technical Data

Belt width [mm]	25	32	50
Allowable tensile load [N]	2280	3040	4680
Weight [kg/m]	0,08	0,11	0,17

Other widths are available on request.

Tooth shear strength

rpm [min ⁻¹]	M _{spez} [Ncm/cm]	P _{spez} [W/cm]	rpm [min ⁻¹]	M _{spez} [Ncm/cm]	P _{spez} [W/cm]	rpm [min ⁻¹]	M _{spez} [Ncm/cm]	P _{spez} [W/cm]
0	2,897	0,000	1200	2,027	2,547	3400	1,514	5,391
20	2,855	0,060	1300	1,990	2,709	3600	1,485	5,598
40	2,817	0,118	1400	1,955	2,866	3800	1,456	5,795
60	2,783	0,175	1440	1,942	2,929	4000	1,429	5,986
80	2,753	0,231	1500	1,923	3,020	4500	1,367	6,442
100	2,725	0,285	1600	1,892	3,170	5000	1,311	6,862
200	2,620	0,549	1700	1,863	3,316	5500	1,260	7,255
300	2,540	0,798	1800	1,836	3,460	6000	1,213	7,619
400	2,458	1,030	1900	1,809	3,599	6500	1,169	7,957
500	2,383	1,248	2000	1,784	3,736	7000	1,128	8,271
600	2,317	1,456	2200	1,736	4,000	7500	1,091	8,568
700	2,258	1,655	2400	1,693	4,256	8000	1,055	8,839
800	2,204	1,846	2600	1,653	4,500	8500	1,023	9,101
900	2,153	2,029	2800	1,615	4,734	9000	0,991	9,337
1000	2,108	2,207	3000	1,580	4,962	9500	0,961	9,555
1100	2,066	2,379	3200	1,546	5,181	10000	0,933	9,766

The total power "P" and the total torque "M" transmitted by the belt, are calculated with the following formulas:

$$P \text{ [kW]} = P_{\text{spez}} \cdot Z_e \cdot Z_k \cdot b / 1000$$

$$M \text{ [Nm]} = M_{\text{spez}} \cdot Z_e \cdot Z_k \cdot b / 100$$

$$Z_e = \frac{Z_k \cdot \arccos \left[\frac{t \cdot (z_g - z_k)}{2 \cdot \pi \cdot A} \right]}{180}$$

P = power in kW

M = torque in Nm

P_{spez} = specific power

M_{spez} = specific torque

Z_e = number of teeth in mesh of the small pulley

Z_{emax} = 12

Z_k = number of teeth of the small pulley

b = belt width in cm

A = centre distance [mm]

t = pitch

Flexibility

Minimum pulley number of teeth and minimum idler diameter			
Drive without reverse bending		Timing pulley Z _{min}	15
		Flat idler running on belt teeth d _{min}	30 mm
Drive with reverse bending		Timing pulley Z _{min}	25
		Flat idler running on belt back d _{min}	60 mm

Minimum available length

Execution	Max width 50 mm
Standard	≥ 800 mm
PAZ	≥ 800 mm

ELA-flex SD® AT K10 - K6

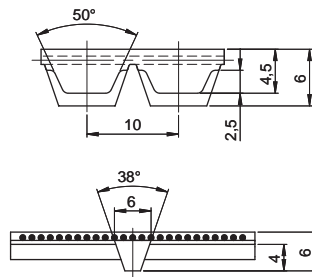
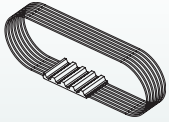

Belt characteristics

- Polyurethane self tracking timing belt with steel tension cords
- Profile AT10 with central guide
- Central guide height 4 mm
- Allows to use pulleys without flanges
- The central guide is notched in order to maximize belt flexibility
- Ideal for conveying applications where a side load is generated by loading/unloading or transferring a product
- **Dual toothing available from 1500 mm**

- Maximum width: 75 [mm]
- Width tolerance: ±0,5 [mm]
- Thickness tolerance: ±0,2 [mm]

Technical Data

Belt width [mm]	32	50	75
Allowable tensile load type V [N]	5120	8090	12400
Weight [kg/m]	0,27	0,36	0,54

Other widths are available on request.

Tooth shear strength

rpm [min ⁻¹]	M _{spez} [Ncm/cm]	P _{spez} [W/cm]	rpm [min ⁻¹]	M _{spez} [Ncm/cm]	P _{spez} [W/cm]	rpm [min ⁻¹]	M _{spez} [Ncm/cm]	P _{spez} [W/cm]
0	12,048	0,000	1200	7,708	9,685	3400	5,317	18,931
20	11,871	0,249	1300	7,534	10,256	3600	5,180	19,529
40	11,706	0,490	1400	7,372	10,807	3800	5,048	20,088
60	11,550	0,726	1440	7,310	11,022	4000	4,924	20,625
80	11,403	0,955	1500	7,219	11,339	4500	4,636	21,846
100	11,265	1,180	1600	7,076	11,855	5000	4,377	22,915
200	10,684	2,238	1700	6,939	12,352	5500	4,140	23,841
300	10,215	3,209	1800	6,810	12,836	6000	3,923	24,648
400	9,793	4,102	1900	6,688	13,305	6500	3,724	25,348
500	9,424	4,934	2000	6,570	13,759	7000	3,538	25,933
600	9,097	5,716	2200	6,349	14,625	7500	3,365	26,423
700	8,808	6,456	2400	6,147	15,447	8000	3,202	26,825
800	8,547	7,159	2600	5,959	16,223	8500	3,048	27,127
900	8,309	7,831	2800	5,782	16,953	9000	2,903	27,358
1000	8,093	8,474	3000	5,618	17,649	9500	2,766	27,516
1100	7,893	9,091	3200	5,464	18,308	10000	2,636	27,598

The total power "P" and the total torque "M" transmitted by the belt, are calculated with the following formulas:

$$P \text{ [kW]} = P_{\text{spez}} \cdot Z_e \cdot Z_k \cdot b / 1000$$

$$M \text{ [Nm]} = M_{\text{spez}} \cdot Z_e \cdot Z_k \cdot b / 100$$

$$Z_e = \frac{Z_k}{180} \cdot \arccos \left[\frac{t \cdot (Z_g - Z_k)}{2 \cdot \pi \cdot A} \right]$$

P = power in kW

M = torque in Nm

P_{spez} = specific power

M_{spez} = specific torque

Z_e = number of teeth in mesh of the small pulley

Z_{emax} = 12

Z_k = number of teeth of the small pulley

b = belt width in cm

A = centre distance [mm]

t = pitch

Flexibility

Minimum pulley number of teeth and minimum idler diameter		
Drive without reverse bending	Timing pulley Z _{min}	15
	Flat idler running on belt teeth d _{min}	50 mm
Drive with reverse bending	Timing pulley Z _{min}	25
	Flat idler running on belt back d _{min}	120 mm

Minimum available length

Execution	Max width
	75 mm
Standard	≥ 1500 mm
PAZ	≥ 1800 mm

ELA-flex SD®

F2

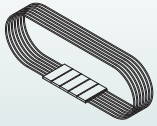

Belt characteristics

- Polyurethane flat belt with steel tension cords
- It is mainly used in drive applications where there is no need for synchronization
- Allows the use of small diameter pulleys

- Width tolerance: ±0,5 [mm]
- Thickness tolerance: ±0,2 [mm]

Technical Data

Belt width [mm]	25	32	50	75	100
Allowable tensile load [N]	4040	4850	8090	12400	16440
Weight [kg/m]	0,007	0,1	0,16	0,24	0,3

Other widths are available on request.

Flexibility

Minimum pulley diameter	Drive without reverse bending [mm]	Drive with reverse bending [mm]
	50	100

Minimum available length

Execution	Max width 100 mm
Standard	≥ 1500 mm
PAZ	≥ 1800 mm

ELA-flex SD®

F2,5

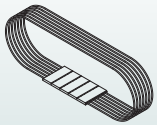

Belt characteristics

- Polyurethane flat belt with steel tension cords
- It is mainly used in drive applications where there is no need for synchronization
- Allows the use of small diameter pulleys

- Width tolerance: ±0,8 [mm]
- Thickness tolerance: ±0,2 [mm]

Technical Data

Belt width [mm]	20	25	50	75	100
Allowable tensile load [N]	2880	4320	9600	15360	21120
Weight [kg/m]	0,08	0,09	0,18	0,27	0,36

Other widths are available on request.

Flexibility

Minimum pulley diameter	Drive without reverse bending [mm]	Drive with reverse bending [mm]
	80	150

Minimum available length

Execution	Max width 100 mm
Standard	≥ 1500 mm
PAZ	≥ 1800 mm

ELA-flex SD®

F3

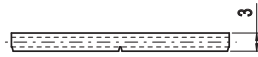
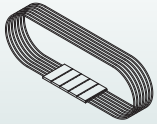

Belt characteristics

- Polyurethane flat belt with steel tension cords
- It is mainly used in drive applications where there is no need for synchronization
- Allows the use of small diameter pulleys

- Width tolerance: $\pm 1,0$ [mm]
- Thickness tolerance: $\pm 0,2$ [mm]

Technical Data

Belt width [mm]	25	30	60	100
Allowable tensile load [N]	9350	11220	22440	37400
Weight [kg/m]	0,20	0,25	0,50	1,00

Other widths are available on request.

Flexibility

Minimum pulley diameter	Drive without reverse bending [mm]	Drive with reverse bending [mm]
		120

Minimum available length

Execution	Max width 100 mm
	Standard
PAZ	≥ 1800 mm

