

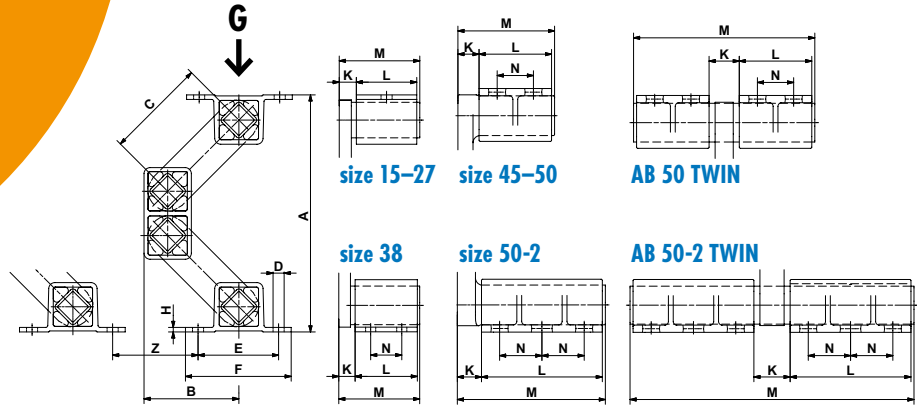

# Oscillating Mountings

Type AB (standard blue)

Type ABI (stainless steel)



Oscillating Mountings

Art. No.	Type	Load capacity Gmin. – Gmax. [N]	A un- loaded	A* max. load	B un- loaded	B* max. load	C	D	E	F	H	K	L	M	N	Weight [kg]
07 051 056	AB 15	50 – 160	168	114	70	88	80	∅7	50	65	3	10	40	52	-	0.5
07 171 107	ABI 15	70 – 180						7x10								0.9
07 051 057	AB 18	120 – 350	208	146	88	109	100	∅9	60	80	3.5	14	50	67	-	1.2
07 171 114	ABI 18							9x15								1.7
07 051 058	AB 27	250 – 800	235	170	94	116	100	∅11	80	105	4.5	17	60	80	-	2.2
07 171 109	ABI 27							11x20								3.3
07 051 059	AB 38	600 – 1'600	305	225	120	147	125	∅13	100	125	6	21	80	104	40	5.1
07 171 110	ABI 38							13x20								7.6
07 051 054	AB 45	1'200 – 3'000	353	257	141	172	140	13x26	115	145	8	28	100	132	58	11.5
07 171 111	ABI 45				137	168										13.5
07 051 061	AB 50	2'500 – 6'000	380	277	150	184	150	17x27	130	170	12	35	120	160	60	19.1
07 171 112	ABI 50															21.9
07 051 055	AB 50-2	4'200 – 10'000	380	277	150	184	150	17x27	130	170	12	40	200	245	70	32.2
07 171 113	ABI 50-2															35.4
07 051 008	AB 50 TWIN	5'000 – 12'000	380	277	150	184	150	17x27	130	170	12	50	120	300	60	35.0
07 051 009	AB 50-2 TWIN	8'400 – 20'000	380	277	150	184	150	17x27	130	170	12	60	200	470	70	54.0

Art. No.	Type	Natural frequency Gmin. – Gmax. [Hz]	Z	Dynamic spring value		Capacity limits by different rpm						Light metal profile	Steel welded construction	Nodular cast iron	ROSTA blue painted	Stainless steel casing
				cd vertical [N/mm]	cd horizontal [N/mm]	720 min <sup>-1</sup> sw max. [mm]	K max. [-]	960 min <sup>-1</sup> sw max. [mm]	K max. [-]	1440 min <sup>-1</sup> sw max. [mm]	K max. [-]					
07 051 056	AB 15	4.0 – 2.8	65	10	6	14	4.1	12	6.2	8	9.3	x	x	x		
07 171 107	ABI 15															x
07 051 057	AB 18	3.7 – 2.6	80	20	14	17	4.9	15	7.7	8	9.3	x	x	x		
07 171 114	ABI 18															x
07 051 058	AB 27	3.7 – 2.7	80	40	25	17	4.9	14	7.2	8	9.3	x	x	x		
07 171 109	ABI 27															x
07 051 059	AB 38	3.0 – 2.4	100	60	30	20	5.8	17	8.8	8	9.3	x	x	x		
07 171 110	ABI 38															x
07 051 054	AB 45	2.8 – 2.3	115	100	50	21	6.1	18	9.3	8	9.3	x	x	x	x	
07 171 111	ABI 45															x
07 051 061	AB 50	2.4 – 2.1	140	190	85	22	6.4	18	9.3	8	9.3			x	x	
07 171 112	ABI 50															x
07 051 055	AB 50-2	2.4 – 2.1	140	320	140	22	6.4	18	9.3	8	9.3			x	x	
07 171 113	ABI 50-2															x
07 051 008	AB 50 TWIN	2.4 – 2.1	140	380	170	22	6.4	18	9.3	8	9.3			x	x	x
07 051 009	AB 50-2 TWIN	2.4 – 2.1	140	380	170	22	6.4	18	9.3	8	9.3			x	x	x

Values in nominal load range at 960 min<sup>-1</sup> and sw of 8 mm  
Acceleration > 9.3 g is not recommended







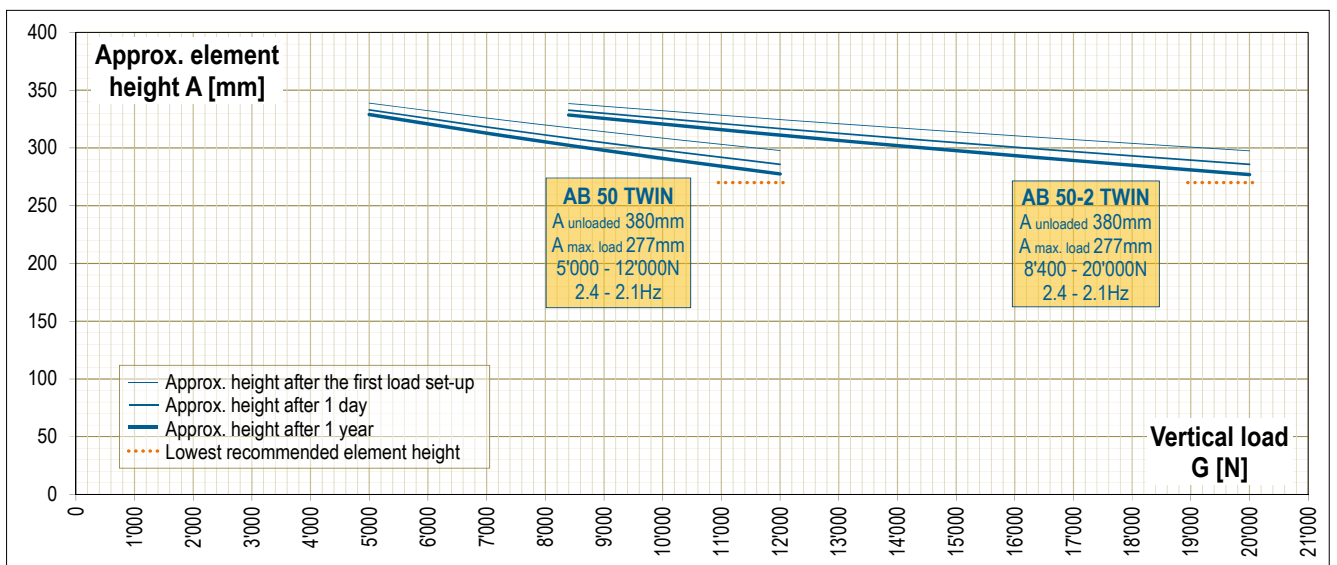
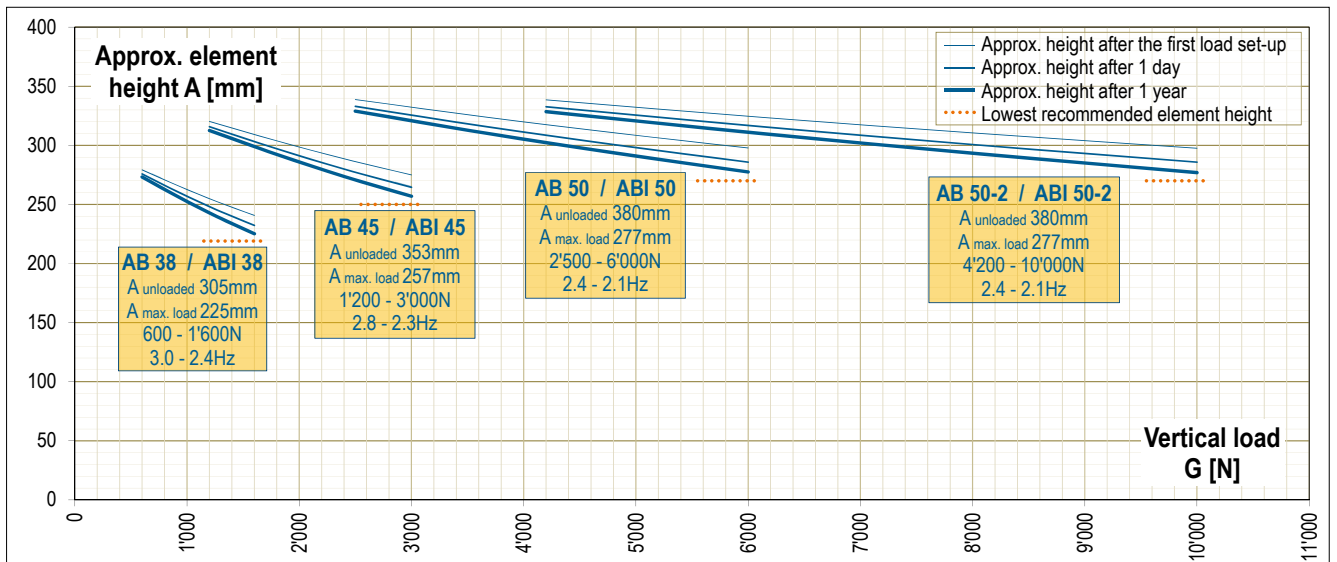
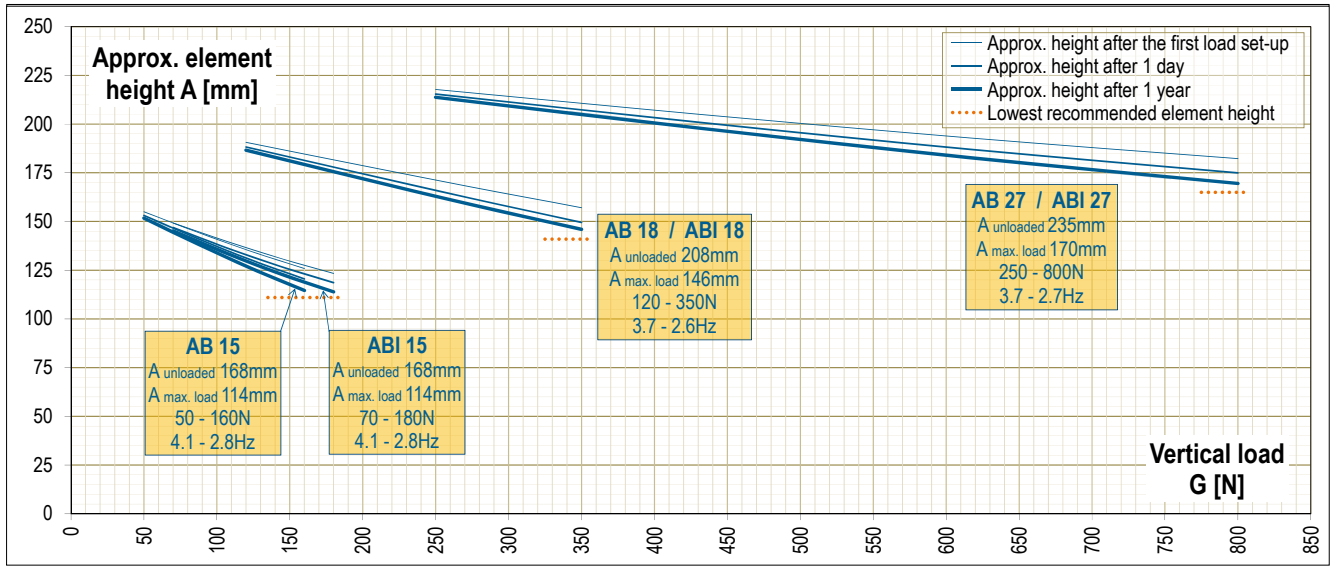

Material structure

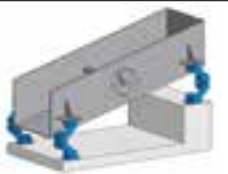
\* compression load Gmax. and cold flow compensation (after approx. 1 year).





# Element heights and cold flow behaviour AB and ABI



# Selection table for free oscillating systems (with unbalanced excitation)

					
		One mass system circular motion screen	One mass system linear motion screen	Two mass system with counterframe	One mass system linear motion screen hanging
	<b>AB ABI</b> Page 2.10	<b>Oscillating Mounting</b> – universal mounting. High vibration isolation and low residual force transmission. Natural frequencies approx. 2–3 Hz. 9 sizes from 50 N to 20'000 N per element.			
	<b>AB-HD ABI-HD</b> Page 2.12	<b>Oscillating Mounting</b> for impact loading and high production peaks. (Heavy Duty) Natural frequencies approx. 2.5–4 Hz. 8 sizes from 150 N to 14'000 N per element.			
	<b>AB-D</b> Page 2.14		<b>Oscillating Mounting</b> in compact design. Optimal in two mass systems as counterframe mounting. Natural frequencies approx. 3–4.5 Hz. 7 sizes from 500 N to 16'000 N per AB-D.		
	<b>HS</b> Page 2.15				<b>Oscillating Mounting</b> for hanging systems. Natural frequencies approx. 3–4 Hz. 5 sizes from 500 N to 14'000 N per HS.

# Selection table for gyratory sifters

	<b>AK</b> Page 2.36	<b>Universal Joint</b> for the support or suspension of positive drive or freely oscillating gyratory sifting machines. 10 sizes up to 40'000 N per AK.	<b>Gyratory sifter upright staying</b>	<b>Gyratory sifter hanging</b>
	<b>AV</b> Page 2.38	<b>Single Joint</b> specially designed with large rubber volume for the suspension of gyratory sifting machines. Models with right-hand and left-hand threads. 5 sizes up to 16'000 N per AV.		

# Technology of free oscillating systems with unbalanced excitation

## Introduction

Free oscillating systems are either activated in using exciters, unbalanced motors or unbalanced shafts.

The oscillation amplitude, type of vibration and the direction of vibration of the screen are determined by the dimensioning and arrangement of these actuators. The excitation force, the angle of inclination of the excitation, the inclination of the screen-box and the position of the center of gravity determine the resulting oscillation amplitude of the device. The oscillation amplitude, and thereby the conveying speed of the machine, can be optimized by augmenting these.

ROSTA spring suspensions support the desired oscillation movement of the screen machine. Through their shape and function, they help to achieve a purely linear conveyor motion without unwanted lateral tumbling.

These ideal spring suspensions harmonically support the running of the vibrating screen. Because of their high spring deflection capacity, they offer a good detuning of the excitation frequency with a very low natural frequency, which guarantees a high isolation effect with regard to the machine substructure. The ROSTA mounts effectively dissipate the large residual force peaks at start-up and shut-down, when passing through the natural frequency of the suspension.



## Circular motion screens



Circular motion screens or circular vibrators are normally excited by unbalanced weights that create a circular rotating oscillation of the screening frame. Relatively low accelerations of the screened material are achieved with this form of excitement. Circular vibrators thereby normally work with a screening frame inclination of  $15^\circ$  to  $30^\circ$ , so that an adequate material throughput is ensured.

It is recommended to mount circular vibratory screens of this kind on ROSTA type AB or AB-HD oscillating mountings. Experience has shown that the positioning of the AB suspensions under circular vibrators should be a mirror-inverted of each other, which, with the above-mentioned frame inclination, will counteract the tendency of the shifting of the center of gravity. If the suspension of the screening frame requires two supporting suspensions per brace support for reasons of capacity, these should also be preferably arranged in mirror-inverted manner for the above-mentioned reason.

## Linear motion screens

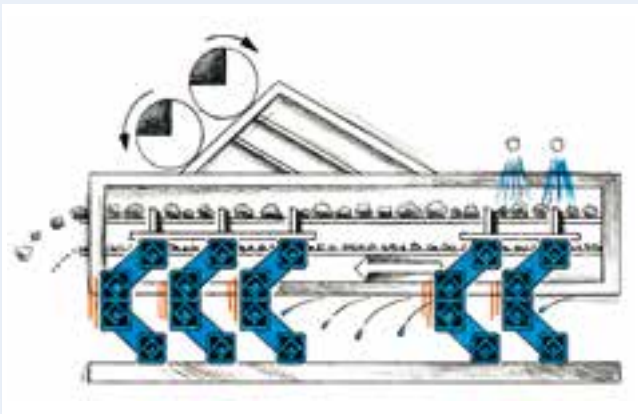

Linear motion screens or linear vibrators are normally excited by two unbalanced motors or by means of linear exciters, as well as through double unbalanced shafts (Eliptex), which generate a linear or slightly elliptical oscillation of the screening frame. Depending on the inclination positioning of the exciter, the angle of throw of the screened product can be adapted to the desired form of processing. A very high acceleration of the screened product, i.e. a higher material throughput, is achieved with linear vibrating screens. The screening frame of the linear vibrator is normally in the horizontal position.

Linear vibrating screens are preferably mounted on ROSTA oscillating mountings type AB or AB-HD. Depending on the positioning of the exciter on the screening frame, the feed-end: discharge-end load distribution can be different. The feed-end side is normally lighter, as the exciters are positioned close to the discharge-end and thereby pull the material through the screening frame; in many cases, the feed-end: discharge-end distribution is thereby 40% to 60%. In the interest of an even suspension, it is thereby recommended to mount the screening frame on six or more ROSTA oscillating mountings. All oscillating mountings should stand in the same direction, with the "knee" pointing in the discharge-end direction.

## Linear motion screens with counterframe

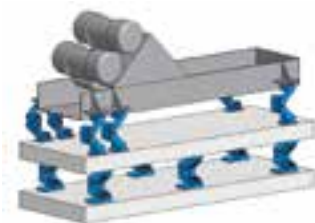

If, due to the demands of the process, large screens are mounted at a very high position in a building or in a purely steel construction, the transmission of the residual forces of a single-mass machine can set the

entire structure into unwanted vibrations. Or if a new and more powerful machine is mounted in an existing building, the residual force transmission could be too high for the older building. The residual force transmission is drastically reduced through the mounting of a counterframe under the screen, with only a negligible loss of oscillation amplitude (compensation movement of the counterframe reduces the oscillation amplitude).

ROSTA also has the ideal supports for the suspension of counterframes, the very compact mountings type AB-D.

## Discharge chutes hanging under silos and bunkers

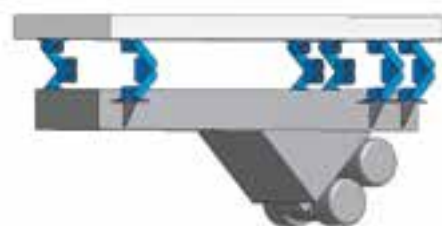

Discharge chutes under silos are normally supported by means of complicated yoke constructions and are suspended on pressure springs. With its HS suspensions (HS = hanging screen), ROSTA offers the possibility of the direct, cost-effective suspension of the discharge unit on silos and bunkers. The geometry of the HS suspensions has been designed to accommodate tensile loads.

# Technology

## Design layout and evaluation

Subject	Symbol	• Example	Unit
Mass of the empty channel and drive	$m_0$	680	kg
Products on the channel		200	kg
of which approx. 50% coupling*		100	kg
Total vibrating mass*	$m$	780	kg
Mass distribution: feed end	% feed end	33	%
discharge end	% discharge end	67	%
Acceleration due to gravity	$g$	9.81	m/s <sup>2</sup>
Load per corner feed end	$F_{\text{feed end}}$	1263	N
Load per corner discharge end	$F_{\text{discharge end}}$	2563	N
<b>• Element choice in example</b>		<b>6x AB 38</b>	
Working torque of both drives	$AM$	600	kgcm
Oscillating stroke empty channel	$sw_0$	8.8	mm
Oscillating stroke in operation	$sw$	7.7	mm
Motor revolutions	$n_s$	960	rpm
Centrifugal force of both drives	$F_z$	30'319	N
Oscillating machine factor	$K$	4.0	
Machine acceleration	$a = K \cdot g$	4.0	g
<b>• Natural frequency suspensions</b>		<b>fe</b>	<b>2.7 Hz</b>
Degree of isolation	$W$	97	%

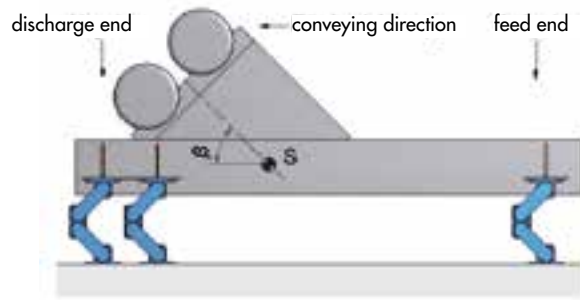

### Calculation formulas

#### Loading per corner

$$F_{\text{feed-end}} = \frac{m \cdot g \cdot \% \text{ feed-end}}{2 \cdot 100} \quad F_{\text{discharge-end}} = \frac{m \cdot g \cdot \% \text{ discharge-end}}{2 \cdot 100} \quad [N]$$

#### Oscillating stroke (Amplitude peak to peak)

$$sw_0 = \frac{AM}{m_0} \cdot 10 \quad sw = \frac{AM}{m} \cdot 10 \quad [mm]$$

#### Centrifugal force

$$F_z = \frac{\left(\frac{2\pi}{60} \cdot n_s\right)^2 \cdot AM \cdot 10}{2 \cdot 1000} = \frac{n_s^2 \cdot AM}{18'240} \quad [N]$$

#### Oscillating machine factor

$$K = \frac{\left(\frac{2\pi}{60} \cdot n_s\right)^2 \cdot sw}{2 \cdot g \cdot 1000} = \frac{n_s^2 \cdot sw}{1'789'000} \quad [-]$$

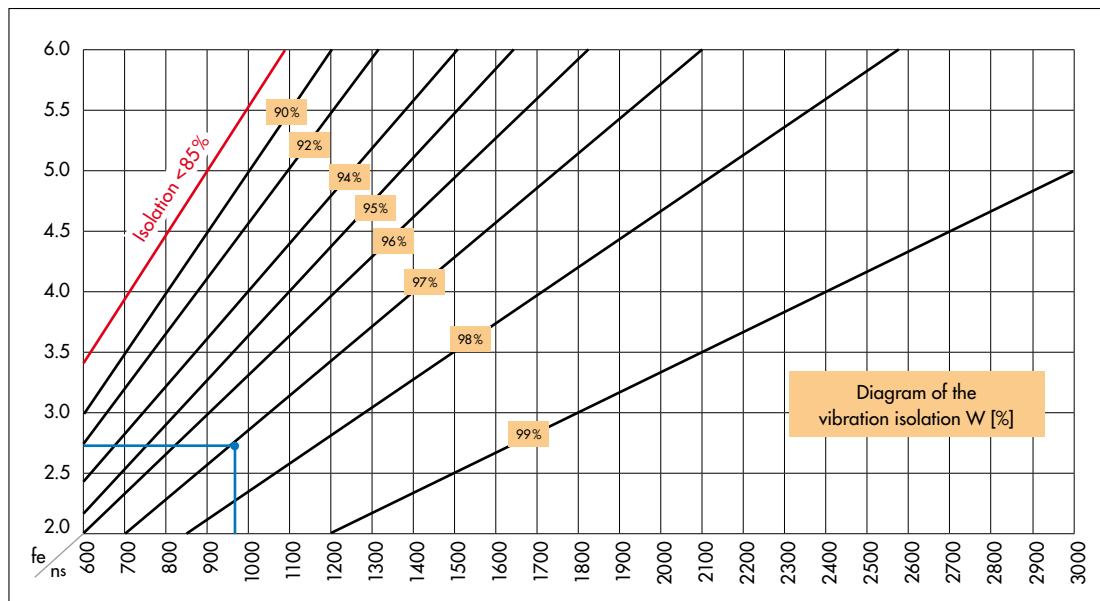

### Vibration isolation

$$W = 100 - \frac{100}{\left(\frac{n_s}{60 \cdot fe}\right)^2 - 1} \quad [%]$$

#### • Example:

The proportion of the relationship between exciter frequency 16 Hz (960 rpm) and mount frequency 2.7 Hz is offering a degree of isolation of 97%.

\* The following has to be observed for the determination of the coupling effect and material flow:

- High coupling or sticking of humid bulk material
- Channel running full
- Fully stacked screen deck with humid material
- Weight distribution with and without conveyed material
- Centrifugal force does not run through the center of gravity (channel full or empty)
- Sudden impact loading occurs
- Subsequent additions to the screen structure (e.g. additional screening deck)





# Technology

## Determination of the average material conveying speed $v_m$

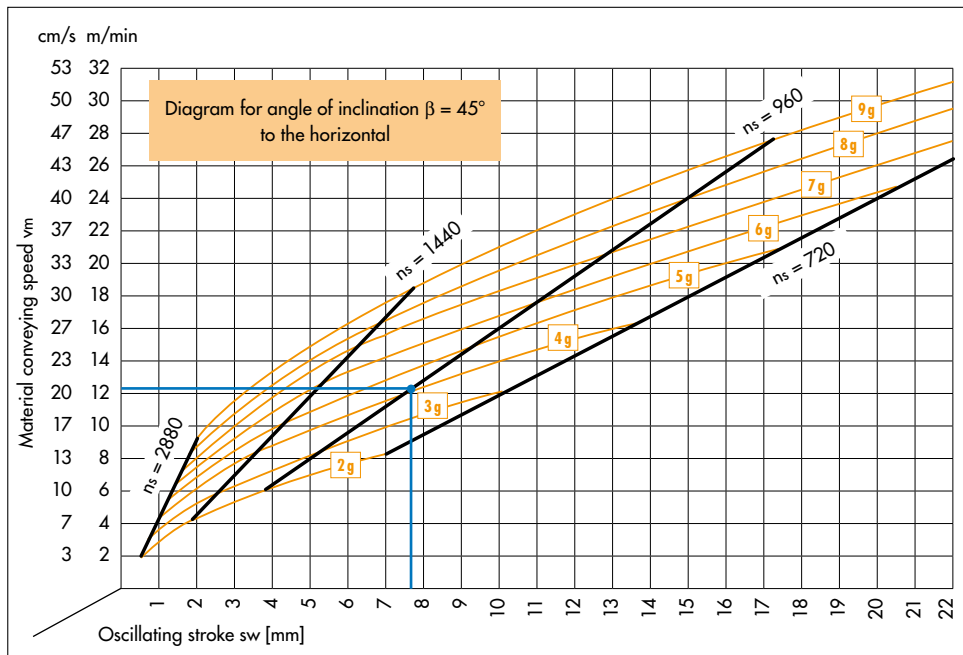

### Main influencing factors:

- Conveying ability of the material
- Height of the bulk goods
- Screen box inclination
- Position of unbalanced motors
- Position of the center of gravity

The material speed on circular motion screens does vary, due to differing screen-box inclination angles.

### • Example:

The horizontal line out of the intercept point of stroke (7.7 mm) and motor revolutions (960 rpm) is indicating an average theoretical speed of 12.3 m/min or 20.5 cm/sec.

## Resonance amplification and continuous running

At the screen start-up and run-out the suspension elements are passing through the resonance frequency. By the resulting amplitude superelevation the four rubber suspensions in the AB mountings do generate a high level of damping which is absorbing the remaining energy after only a few strokes. The screen box stops its motion within seconds.

Laboratory measurements of a typical development of the residual forces on a ROSTA screen suspension:

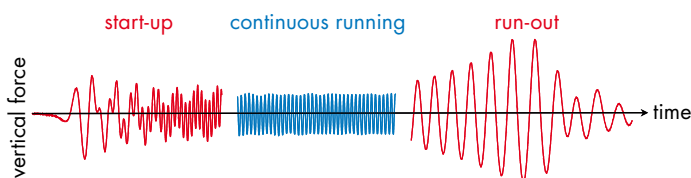

## Alignment of the elements

If the suspensions for linear motion screens are arranged as shown on page 2.7, a harmonic, noiseless oscillation of the screen will result. The rocker arm fixed to the screen carries out the greater part of the oscillations. The rocker arm fixed to the substructure remains virtually stationary and ensures a low natural frequency, and thereby also a good vibration isolation. The mounting axis has to be arranged to be at right angles ( $90^\circ$ ) to the conveying axis, with maximum tolerance of  $\pm 1^\circ$ .

